

SUPER EGO

Pipe tools solutions

06/2017  



Made in Spain

Agarre • Roscado • Corte • Curvado • Soldadura • Mantenimiento
Tightening • Threading • Cutting • Bending • Soldering • Maintenance

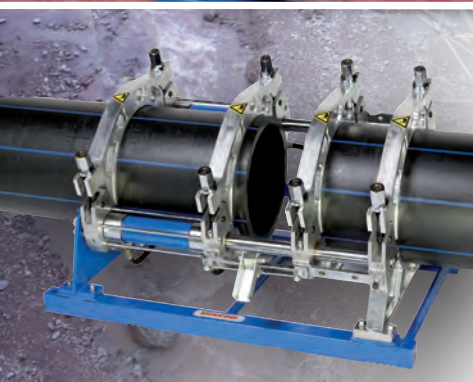
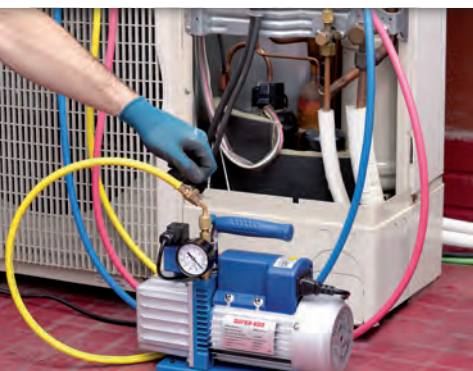

Equipos y herramientas para tubo

Pipe tools solutions

Herramientas

Llaves y tenazas	10	Pipe wrenches and pliers	10
Tornillos de banco y mordazas	27	Vises	27
Banco de trabajo	28	Tristands	28
Roscado	30	Threading	30
Ranurado	41	Grooving	41
Cortatubos	43	Tube cutters	43
Curvado	54	Bending	54
Abocinadores	60	Flaring tools	60
Bombas de comprobación	63	Testing pump	63
Desatasco	66	Drain cleaning	66

Servicios generales

Destornilladores	74	Screwdrivers	74
Alicates	78	Pliers	78
Sierras	81	Saws	81
Tijeras	83	Scissors	83
Llaves	85	Wrenches	85
Juego de llaves de vaso de carraca	88	Combined socket sets	88
Llaves Allen	90	Allen wrenches	90
Discos de corte	91	Cutting discs	91
Bolsa portaherramientas	92	Tool bag	92
Obturadores neumáticos para tuberías y pozos	93	Pneumatic plugs for pipes and wells	93

Soldadura

Sopletes a cartuchos desechables	100	Torches for disposable gas cartridges	100
Cartuchos desechables	104	Disposable gas cartridges	104
Sopletes a manguera	105	Hose connection torches	105
Sopletes a manguera con conexión de espiga	106	Handles with nipple connection hose	106
Accesorios para butano/propano	107	Butane/propane accessories	107
Socket	110	Socket	110

Equipos y herramientas para HVAC&R

HVAC&R service tool

Bombas de vacío	114	Vacuum pumps	114
Unidad de recuperación de refrigerante	115	Refrigerant recovery device	115
Manómetros analógicos	116	Analogue manifolds	116
Mangueras	116	Hoses	116
Báscula	117	Scale	117
Abocinador	117	Flaring tool	117
Detector	118	Detector	118
Termómetro digital	118	Digital-thermometer	118

Equipos soldadura de tuberías plástico

Plastic pipe welding

Máquinas para soldadura a tope	122	Butt welding machines	122
--------------------------------	-----	-----------------------	-----

Líder

SUPER-EGO, líder desde hace 69 años en la fabricación de equipos y herramientas para tubo y soldadura. Somos el primer fabricante Español de herramienta en exportaciones a todo el mundo.

Líder en tecnología asociada a nuestros productos que viene dada por continuas e importantes inversiones en nuestras instalaciones, maquinaria y procesos de producción.

Con la aparición de nuevos materiales y sistemas de unión desarrollamos herramientas específicas para cada trabajo, un proceso de mejora continua que nos permite ofrecer a nuestros clientes y usuarios una mayor y mejor gama de productos en un entorno cada día más competitivo.

Leader

SUPER-EGO has been leader ever since 69 years ago in the manufacture of equipment and pipe and welding tools for plumbing and heating. It is leader in Spain, Europe and worldwide reference for wrenches, dies and pipe cutters. We are the first Spanish tool manufacturer in exports worldwide.

It is leader in the technology associated to our products thanks to continual and important investments in our facilities, machinery and production processes.

Based on the emergence of new materials and joint systems, we manufacture specific tools for each work, a continual improvement process that enables providing our customers and users with a wider and better range of products in a more and more competitive environment.



1946

SUPER-EGO nace en 1946 a orillas del río Ego en Eibar (Guipuzcoa)

SUPER-EGO set up in 1946 next to the river Ego in Eibar (Guipuzcoa)



2015

Ubicación actual de **SUPER-EGO** en Abadiño (Bizkaia)
SUPER-EGO is currently located in Abadiño (Bizkaia)

Fabricante

Fabricamos equipos y herramientas para tubo y soldadura con los sistemas más modernos de fabricación (SMED, KAIZEN, KANBAN).

Nuestras herramientas cuentan con los últimos procesos de temple (de atmósfera controlada, de inducción y distensionado) que confieren a nuestras herramientas una calidad reconocida y valorada que hace posible su venta a los clientes más exigentes de todo el mundo, industria química, industria del petróleo, minería, etc.

Los mejores fabricantes del mundo confían en SUPER-EGO para la fabricación de las herramientas.



Spanish Made, 2 centros de producción y más de 250 personas a su servicio. En Super-Ego apostamos por la calidad y el servicio a nuestros clientes y usuarios, aportando riqueza en nuestro entorno y siendo cada día más competitivos dentro del mercado global.

Manufacturer

We manufacture pipe and welding equipment and tools through leading edge manufacturing systems (SMED, KAIZEN, KANBAN).

Our tools are based on the latest hardening processes (controlled atmosphere, induction and stress relieving), which give our tools accredited and valued quality enabling their sale to most demanding customers worldwide, chemical industry, oil industry, mining, etc.

The world's best known manufacturers trust SUPER-EGO for custom manufacture of their brand.

Spanish Made, 2 production facilities and more than 250 persons working for them. We at Super-Ego are committed to quality and service to our customers and users, making a contribution towards the wealth around us and being more and more competitive in the international market.

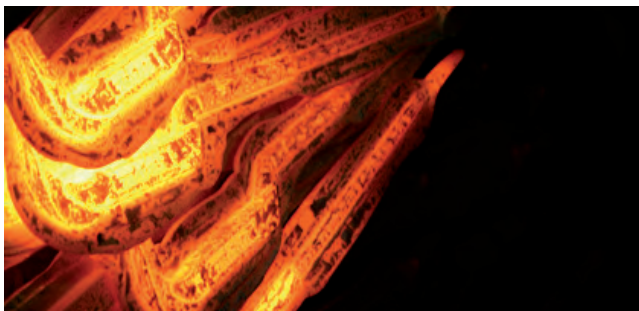

Proceso de forja y pintado epoxi.

Como fabricante de herramienta para tubo controlamos todo el proceso de fabricación de nuestros productos desde la materia prima hasta el empaquetado y distribución.



Forging process and epoxy painting.

As a pipe tool manufacturer, we control the complete production process from raw materials to packaging and distribution.



Los temple y durezas un proceso clave en nuestra fabricación.

Hardening and hardness a key production process.

Innovación

Líder en I+D+I con un potente desarrollo propio apoyado en una red de importantes relaciones con centros tecnológicos, fundaciones y universidades.

SUPER-EGO se encuentra continuamente inmerso en un proceso de mejora de nuestros productos para ofrecer una mayor y mejor gama a nuestros clientes en un entorno cada día más competitivo.

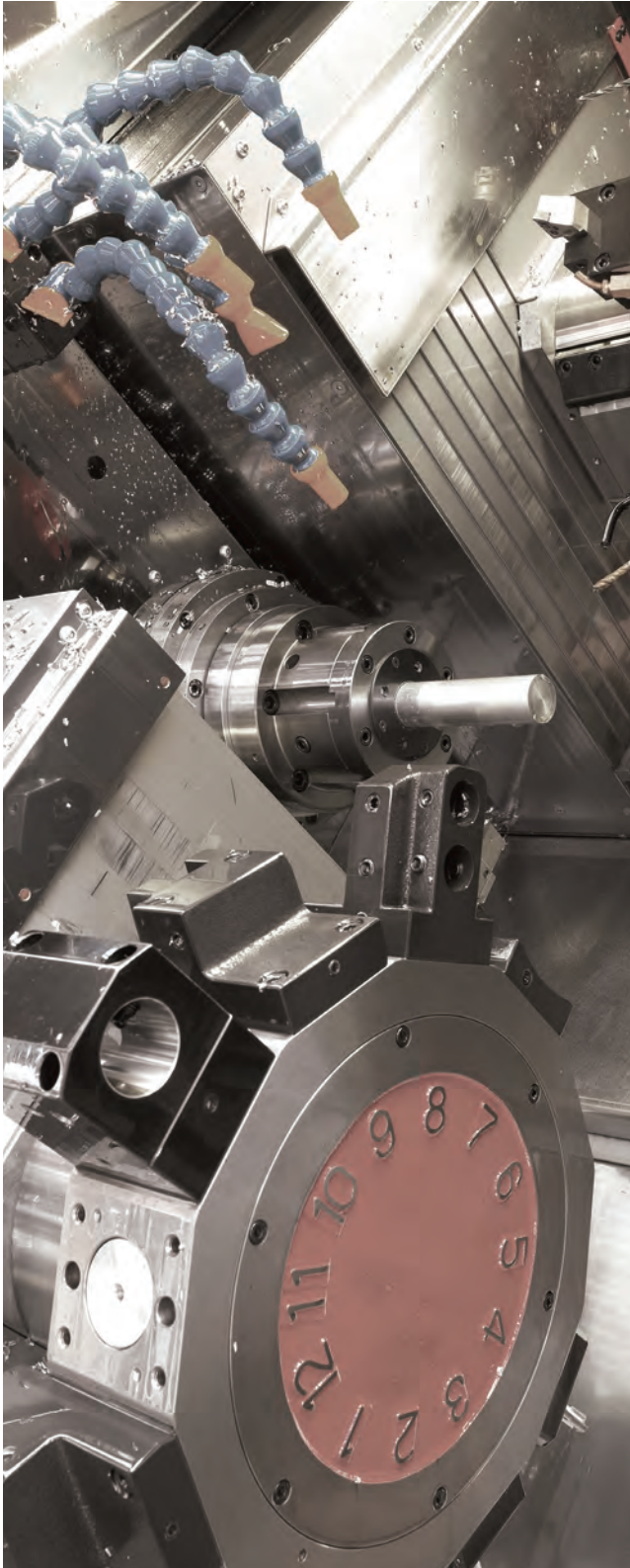

Innovation

Leader in R&D and Innovation with powerful own development program supported by a network of important relations with technological centres, foundations and universities.

SUPER-EGO is continually going through a product improvement process to offer a wider and better range of products to our customers in a more and more competitive environment.

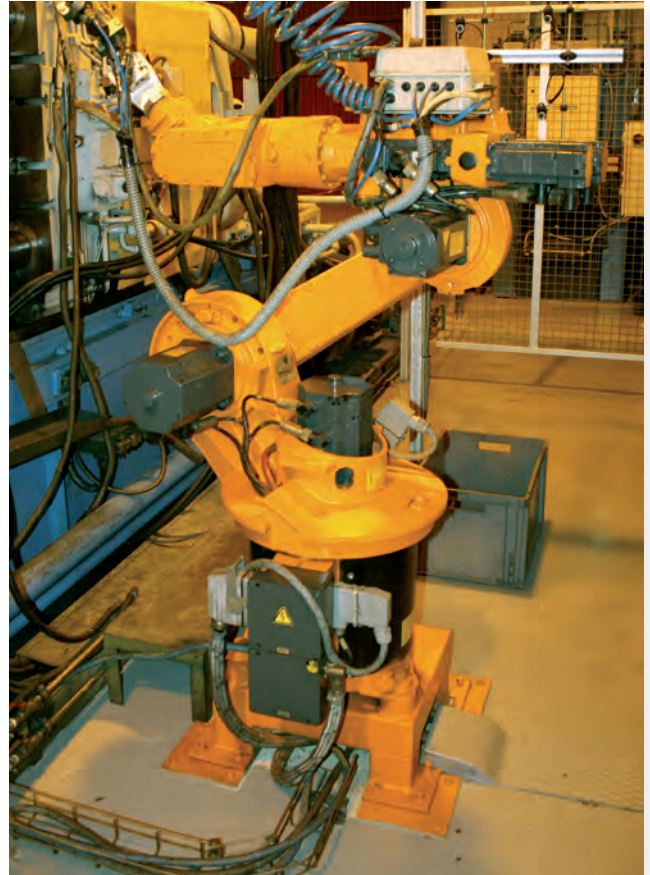

Robotización de procesos de fabricación

Robotic manufacturing processes



Calidad

Desde 1994, SUPER-EGO cuenta con la certificación TUV Nord para las normas ISO 9000 (aseguramiento de la calidad en el diseño, fabricación, distribución y servicio postventa de nuestros equipos y herramientas) e ISO 140001 (aplicación del principio de prevención y mejora continua en la gestión medioambiental), normas que han sido renovadas periódicamente hasta la actualidad.



Testado unitario de todos nuestros equipos.

Quality

Since 1994, SUPER-EGO counts on TUV Nord certification for ISO 9000 (quality assurance for design, production, distribution and after sales service of our equipment and tools) and ISO 140001 (implementation of prevention and continual improvement of environmental management systems), standards that have been updated periodically until now.

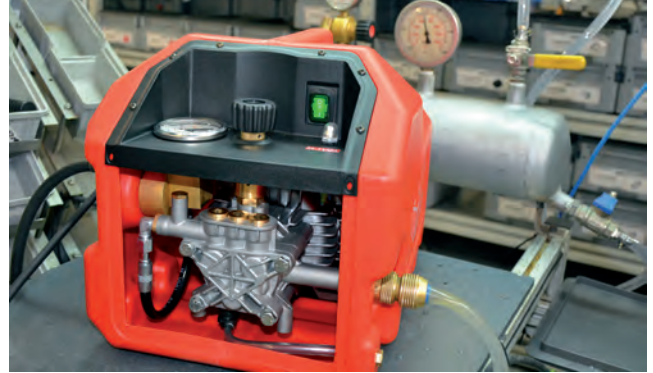

Unit tests of all our equipment.



En SUPER-EGO nos hemos comprometido a respetar el medio ambiente para proporcionar un entorno limpio, próspero y agradable a las futuras generaciones.

We at SUPER-EGO are committed to respect the environment in order to provide a clean, thriving and pleasant environment for future generations.



Control y verificación del proceso. Aseguramiento de la calidad.
Process control and verification. Quality assurance.



Herramientas

Llaves
Tenazas
Tornillos de banco y mordazas
Banco de trabajo
Terrajas manuales
Roscado eléctrico
Ranurado
Cortatubos
Curvado manual
Curvado eléctrico
Abocinadores
Bombas de comprobación
Desatasco

10
22
27
28
30
33
41
43
54
58
60
63
66

Tools

Pipe wrenches
Pliers
Vises
Tristands
Manual threading
Electric threading
Grooving
Tube cutters
Manual bending
Electrical bending
Flaring tools
Testing pump
Drain cleaning

10
22
27
28
30
33
41
43
54
58
60
63
66

Llaves Heavy Duty

Permite trabajar con una sola mano.
Mayor capacidad que una llave Stillson del mismo tamaño.

 GGG-W-651e Type II Class A
UNE 16-554

 Made in Spain

Heavy Duty wrenches

Can be used with only one hand.
Higher capacity than a Stillson wrench of the same size.

Mordaza superior fabricada en acero especial y con doble tratamiento térmico.

Top hook manufactured in special steel and double heat-treated.

Mordaza inferior con asiento apropiado para evitar carga sobre el pasador.

Lower jaw with proper seat to avoid load on pin.

Dientes con una geometría especial que permite una buena fijación al tubo.

Teeth with special geometry for good tube grip.

Tuerca de ajuste moleteada y templada, totalmente antideslizante.

Knurled and tempered adjusting nut, full anti slip.



Diferente apertura de bocas con un mismo mango. Ajuste rápido de la apertura gracias a la escala en la lengua.

Different jaw openings for the same handle size. Quick preset of the opening using scale on hook.



Proporcionan un apriete instantáneo del tubo y una acción de carraca perfecta, gracias al conjunto de resortes planos y helicoidales.

Set of flat and coil springs for instant pipe grip and perfect ratchet action.



Mango monoblock fabricado en fundición de hierro con sección de doble "T" que minimiza el peso.

Monoblock handle made in cast iron with double "T"-shaped minimizes weight.



Orificio en el mango para almacenar la herramienta colgada.

Hole in handle for hanging the tool.



Las piezas que sufren un mayor desgaste son reemplazables. Consulte nuestros repuestos.
Wearing parts replaceables. Consult our spare parts.



Llaves de gran resistencia

Diseñadas para realizar los trabajos más duros en la instalación y el mantenimiento de tuberías.

Great strength wrench

Designed for heavy work in pipe installation and maintenance.



102 Llave Heavy Duty
102 Heavy Duty Wrench

102 Llave Heavy Duty

102 Heavy duty wrench



Made in Spain

No.	L		A max. Ø		B	C	kg	 
	in	mm	in	mm	mm	mm		
NUEVA NEW 1000001639	6	150	3/4	20	11,5	11,2	0,2	• 4
102080000	8	200	1	35	16,5	14,0	0,3	• 4
102100000	10	250	1.1/2	49	21,5	17,0	0,8	• 4
102120000	12	300	2	61	23,0	21,0	1,2	• 4
102140000	14	350	2	61	26,0	21,0	1,6	• 4
102180000	18	450	2.1/2	77	29,0	26,0	2,6	• 2
102240000	24	600	3	90	33,0	28,0	4,4	• 1
102360000	36	900	5	141	44,0	32,5	8,7	• 1
102480000	48	1.200	6	167	58,0	36,0	15,6	• 1
NUEVA NEW 1000001638	60	1.300	8	200	85,2	41,6	23,0	• 1

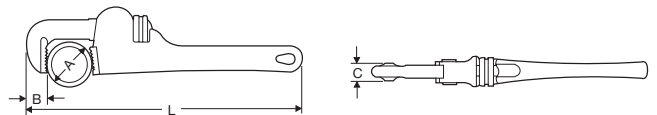

112 Llave Heavy Duty curva



Cabeza acodada diseñada para trabajos en tuberías de difícil acceso (rincones restringidos, cerca del suelo, etc ...)

112 Offset pattern heavy duty wrench

Offset wrench head is designed for working on pipes in confined spaces (tight corners, near the floor, etc.)



Made in Spain

No.	L		A max. Ø		B	C	kg	 
	in	mm	in	mm	mm	mm		
112100000	10	250	1.1/2	49	21,5	17	0,7	• 4
112140000	14	350	2	61	26,0	21	1,4	• 4

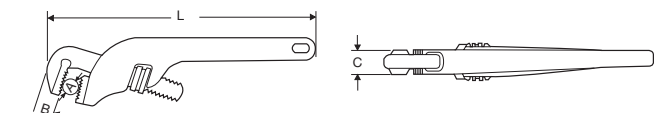



40% más ligera

El mango monoblock de las llaves de aluminio SUPER-EGO está fabricado en aleación de aluminio ultraligero templado, llegando a ser un 40% más ligeras que las llaves Heavy Duty pero respondiendo en los trabajos más exigentes.

40% lighter

The SUPER-EGO aluminium wrench monoblock handle is made of ultralight tempered aluminium resulting into 40% lighter weight as compared with Heavy Duty Wrenches and yet they cope with most demanding work.

104 Llave de aluminio
104 Aluminium pipe wrench

104 Llave de aluminio

104 Aluminium pipe wrench



Made in Spain

GGG-W-651e Type II Class C
UNE 16-554

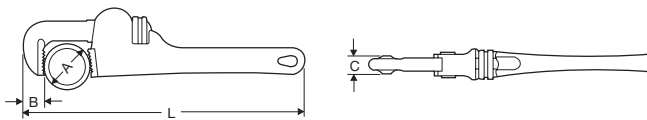

No.	L in mm	A max Ø in mm	B mm	C mm	kg			
104100000	10 250	1.1/2 49	22,0	17,0	0,4	•	4	
104140000	14 350	2 61	26,0	21,0	0,9	•	4	
104180000	18 450	2.1/2 77	29,0	26,0	1,6	•	2	
104240000	24 600	3 90	33,0	28,0	2,5	•	1	
104360000	36 900	5 141	44,0	32,5	5,2	•	1	
70164	48 1.200	6 167	58,0	36,0	8,7	•	1	
1000001640	60 1.300	8 200	85,2	41,6	12,6	•	1	
Set 2 llaves aluminio / Set 2 aluminium pipe wrenches								
P01100100	104140000 - 14" + 104180000 - 18"							1

NUEVA
NEW

105 Llave de aluminio curva

Su diseño permite trabajar en espacios reducidos, cuando el tubo está cerca de la pared y cuando sólo se dispone de un ángulo pequeño de giro.

105 Offset aluminium heavy duty wrench

Designed to work in confined spaces, when the tube is closed to the wall and when only a small angle of rotation is available.



Made in Spain

GGG-W-651 Type II Class C
UNE 16-554

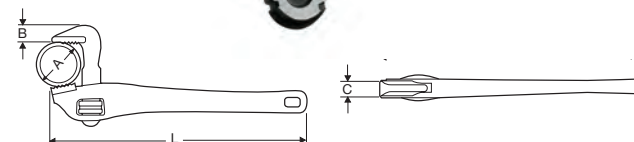

No.	L in mm	A max Ø in mm	B mm	C mm	kg		
105140000	14 350	2 61	24	23	0,8	•	1
105180000	18 450	2.1/2 77	29	27	1,4	•	1

101 Llave Stillson

Diseñada para trabajos de alto nivel de exigencia

101 Stillson pipe wrench

Designed to the most demanding work.

Mango y mordaza móvil forjados en acero especial con doble tratamiento térmico que garantiza una máxima resistencia de la llave al mismo tiempo que una resistencia ilimitada al desgaste de los dientes.

Handle and moving jaw forged in special steel with dual heat treatment for maximum strength and maximum teeth wear resistance.



Diferente apertura de bocas con un mismo mango. Ajuste rápido de la apertura gracias a la escala en la lengua.

Different jaw openings for the same handle size. Quick preset of the opening using scale on hook.



Doble resorte que asegura un agarre inmediato y una acción de carraca perfecta.

Double spring for instant pipe grip and perfect ratchet action.



Las piezas que sufren un mayor desgaste son reemplazables. Consulte nuestros repuestos.
Wearing parts replaceables. Consult our spare parts.



Made in Spain

GGG-W-651e Type II Class A
UNE 16-554

No.	L		A max. Ø		B	C	kg	🔧	📦
	in	mm	in	mm					
101080000	8	200	3/4	28	17	12	0,3	•	4
101100000	10	250	1	35	22,5	16	0,6	•	4
101120000	12	300	1.1/4	43	43	16,5	0,7	•	4
101140000	14	350	1.1/2	49	49	20,5	1,1	•	4
101180000	18	450	2	61	30	23,5	1,8	•	2
101240000	24	600	2.1/2	77	38	27	3,2	•	1
101360000	36	900	3.1/2	103	47,5	30	5,8	•	1

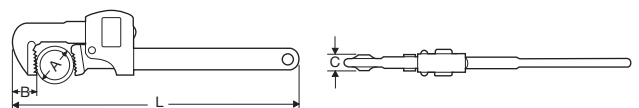

Llaves suecas

Llave totalmente forjada, sin puntos de soldadura

Swedish wrenches

Totally forged wrench with no welds

1



Fabricada en acero al cromo vanadio completamente forjada en un pieza, sin partes soldadas.

Chrome vanadium steel, forged in one piece, no welded parts.

Refuerzo guía en mango central.

Guide reinforcement on central handle.

Alojamiento reforzado, 40% mas de par.

Reinforced housing, 40% more torque.



La dureza de la tuerca proporciona un mejor comportamiento, junto con una sección roscada al 100% para una superficie de contacto total.

The hardness of the nut provides better performance, with 100% threaded section for full surface contact.



Mordazas estrechas.

Narrow jaws.



Mordazas en "S" para un agarre seguro en 3 puntos
"S" design jaws for a perfect pipe grip with 3 points of contact.

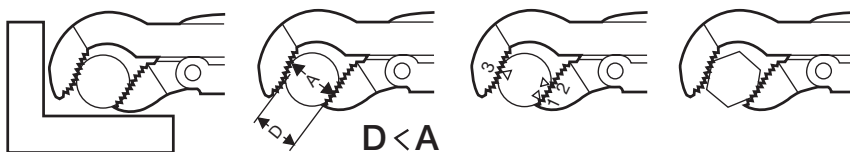

Mordazas en "S"
"S" design jaws



Mordazas en 90°
90° jaws angle



Mordazas en 45°
45° jaws angle



Las piezas que sufren un mayor desgaste son reemplazables. Consulte nuestros repuestos.
Wearing parts replaceables. Consult our spare parts.

3 modelos para diferentes necesidades.
3 models for different needs.



145 Llave sueca "S"
145 Swedish wrench "S"

145 Llave sueca "S"

Es la llave sueca más apreciada por los profesionales.
Diseño de las bocas tipo "S" . 3 puntos de apoyo.

No.	A Ø		L	B	C	kg			
	in	mm					mm	mm	mm
145050000	1/2	25	235	15	7	0,3	•	•	1
145100000	1	40	320	18	10,5	0,7	•	•	1
145150000	1.1/2	55	416	24	11	1,3	•	•	1
145200000	2	67	535	28	12,5	2,4	•	•	1
145300000	3	103	640	30	15,5	3,4	•	•	1
Set 2 llaves suecas "S" / Set 2 swedish wrenches "S"									
P14534300	145100000 - 1"		+ 145150000 - 1.1/2"				•	•	1

145 Swedish wrench "S"

The Swedish wrench most appreciated by professionals.
Special "S" design jaw. 3 points of contact.



141 Llave sueca 90°

Bocas en ángulo 90°.

No.	A Ø		L	B	C	kg			
	in	mm					mm	mm	mm
141100000	1	40	320	18	15,5	0,7	•	•	1
141150000	1.1/2	55	420	20	18,5	1,3	•	•	1
141200000	2	67	560	25	22,5	2,4	•	•	1
141300000	3	103	655	29	28	4,1	•	•	1

141 Swedish wrench 90°

Jaws 90° angle.

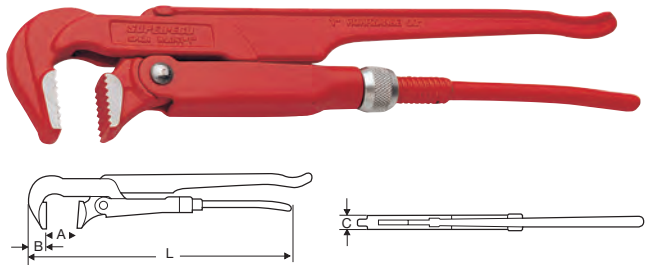

143 Llave sueca 45°

Bocas en ángulo 45°.

No.	A Ø		L	B	C	kg			
	in	mm					mm	mm	mm
143050000	1/2	25	237	17	11,5	0,4	•	•	1
143100000	1	40	314	22	13	0,7	•	•	1
143150000	1.1/2	55	426	24	15,5	1,2	•	•	1
143200000	2	67	570	31	19,5	2,5	•	•	1

143 Swedish wrench 45°

Jaws 45° angle.

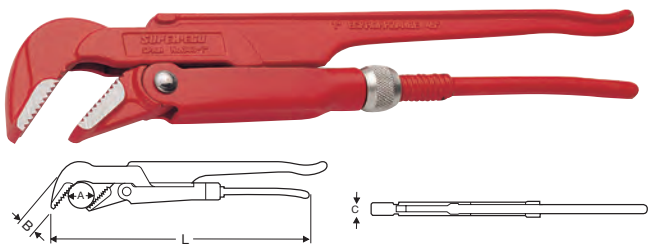

540 Tenaza pica roscas

Completamente estampada de acero al cromo vanadio.
Templada y revenida.

Los rodillos moleteados de acero tratado térmicamente desbastan los tubos roscados permitiendo la perfecta adherencia de cintas de teflón u otros materiales de junta.

No.	A Ø inch		L	B	kg			
	min	max				mm	mm	kg
540010000	3/8	2	335	46	1,1	•	•	1
Rodillos / rollers								
540012000						•	•	1

540 Pipe thread roughing wrench

Completely drop forged out of Chrome Vanadium Steel.
Hardened and tempered.

Knurled rollers made from heat treated steel allow a perfect adherence of teflon tape or any other sealing material.

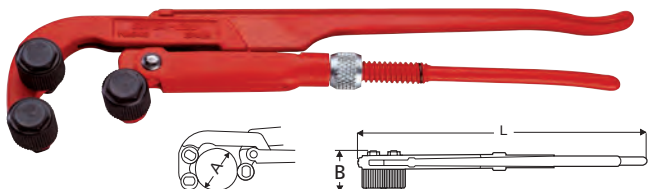



Máxima fuerza de sujeción sin marcas en el tubo

Para aplicación en tubos de plástico, metal, filtros ... con superficies pulidas o rugosas. Las llaves de correa proporcionan la misma capacidad de agarre que una llave convencional sin deformación del tubo. Con la misma longitud de cinta abarca diferentes diámetros del tubo con un gran efecto palanca.

Maximum grip without marking the tube.

For applications in plastic tubes, metal, filters...with polished or rough surfaces. Strap wrenches provide the same grip than conventional wrenches without tube distortion. Different tube diameters can be covered with the same strap length with large leverage effect



123 Llave de correa PE
123 Strap wrench PE

123 Llave de correa PE

Gran transmisión de torsión.

Fabricada en aluminio cuenta con ajuste automático rápido y preciso, especialmente con tubos de plástico.

Correa fácilmente reemplazable y reforzada de PE especial (polyester-nylon) con la que se consigue una mejor transmisión.

El pomo giratorio garantiza un apriete perfecto.

Apoyos de goma para tubos pequeños < 50 mm Ø.

123 Strap wrench PE

Great improved torque.

Made of aluminium with automatic, quick and fine adjustment, especially with plastic pipes.

Special reinforced PE and easy strap replacement (polyester-nylon) resulting a better improved torqued and a maximum working load.

Turn knob for a perfect grip.

Rubber supports for small pipes < 50 mm Ø.

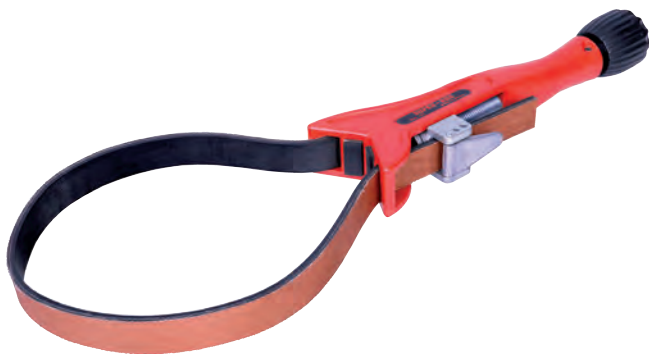

Apoyo en V sobredimensionado para mejor protección del tubo
Oversized V support for a better pipe protection.

Presentación / Product display



No. 123010000



No.	Ø min.	Ø max.	L mm	kg		
123010000	20	200	110	0,2	•	1
Correa de repuesto / Spare strap						
123021000			110			1

108 Llave de correa nylon

Agarre sin dañar superficies.

Fabricada en aluminio cubierta con pintura epoxy.

Correa reemplazable muy robusta de nylon especial que permite un agarre rápido sin dañar los tubos cromados.

De gran uso en el sector de automoción para el cambio de filtro de aceite.

Dos tamaños de correa, corta de 435 mm y larga de 950 mm.

108 Strap wrench nylon

Grip without surface damage.

Made of aluminium coated with epoxy paint.

Very robust special nylon strap replacement for quick grip without damaging polished surfaces.

Use in the automotive industry for the oil filters changes.

Two strap sizes; short: 435 mm and long: 950 mm.



Correa de nylon, no daña los tubos cromados.
Nylon strap, without damaging polished surfaces

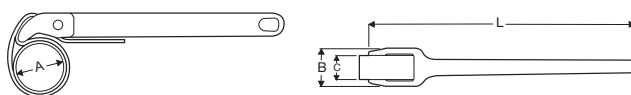

No.	L in	L mm	A max. Ø in	A max. Ø mm	B mm	C mm	kg		
108010000	12	300	3	90	42	27	0,2	•	4
108020000	12	100	8	220	42	27	0,2	•	4
Correa de repuesto / Spare strap									
70268			Ø 3" L: 435 mm						1
70269			Ø 8" L: 950 mm						1



Reversibles

El diseño especial de los dientes permite apretar o aflojar alternativamente la tubería y la dirección sin cambiar la posición de la llave.

Reversibles

Special teeth design allows tightening or releasing the pipe alternatively and the direction without changing the wrench position.

Acción de carraca eficiente en ambos sentidos.

Ratchet action from either side.

Cadena remachada de acero templado de gran resistencia para un agarre seguro y un afloje rápido.

Very strong riveted tempered steel chain for safe grip and quick release.



103 Llave de cadena reversible

Robusta y apta para las más duras condiciones de trabajo.

Las mordazas y el cuerpo son forjados.

Mordazas templadas de acero especial y fácilmente reemplazables.

Testada en extracciones petrolíferas y construcción de gaseoductos.

Terminal remachado entre cadena y mordazas reforzado para proporcionar más seguridad y resistencia.

103 Reversible chain wrench

Very and robust for the toughest working conditions.

Jaws and handle are forged.

Tempered jaws in special steel and easily replaced.

Tested in oil rigs and gas pipeline construction.

Reinforced riveted terminal between chain and jaw for increased safety and strength.



Made in Spain

No.	A max. Ø in mm	L mm	B mm	C mm	L mm	Fuerza de tensión kg Tensile Str. kg	kg		
103300000	1.1/2 49	350	38	8	344,5	3.100	1,4	•	1
103310000	2.1/2 77	685	49	9	451,5	4.800	3,5	•	1
103320000	4 115	940	60	13	566,5	7.900	6,7	•	1
103330000	6 167	1.122	75	20	808,0	15.000	12,6	•	1
103340000	8 220	1.278	79	20	1.010,6	15.000	17,0	•	1
103350000	12 325	1.625	82	20	1.417,6	15.000	24,2	•	1

GGG-W-651 Type III Class A
UNE 16-555

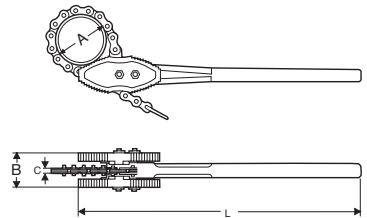

107 Llave de cadena reversible

Gran transmisión de torsión.

Completamente forjada, con doble tratamiento térmico.

Cadena de acero templado fácilmente reemplazable de alta resiliencia y resistencia.

107 Reversible chain wrench

Great improved torque.

Totally forged with dual heat treatment.

Tempered steel easy chain replacement of great resilience and strength.



Made in Spain

No.	L in mm	A max. Ø in mm	B mm	C mm	L mm	kg		
107120000	12 300	1/4 - 4 115	19	8	439	1,2	•	4
Cadena de repuesto / Spare chain								
70239			Ø 4" L: 439 mm					1

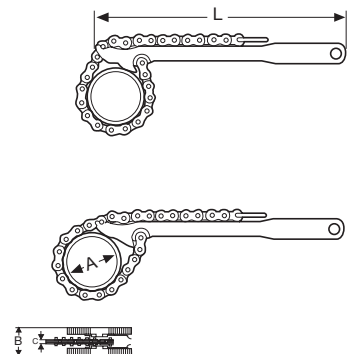



118 Llave de lavabo

Forjada en acero especial.
Espiga con mordaza integrada.



118 Basin wrench

Forged from a special steel.
Shank with a built-in jaw.

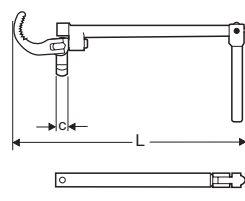

Made in Spain

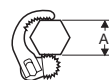

No.	A max.		L	C	kg	
	in	mm				
118010000	3/8-1.1/4	10-32	265	14	0,475	• 1

109 Llave de lavabo

Mordazas forjadas con autoamarre mediante un sistema de muelle.
Mango y espiga revestido de zinc.



109 Basin wrench

Forged jaws with self-grip by means of spring system.
Zinc coated handle and shank.

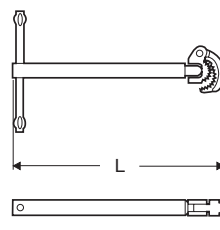

Made in Spain

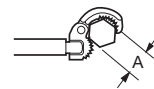

No.	A max.		L	C	kg	
	in	mm				
109010000	3/8-1.1/4	10-32	287	14	0,490	• 1

117 Llave de lavabo

La espiga telescópica permite un ajuste rápido de la longitud requerida.
Mango y espiga revestido de zinc.



117 Basin wrench

Telescopic shank allows quick adjustment to desired length.
Zinc coated handle and shank.

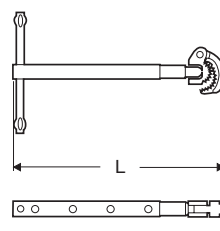

Made in Spain

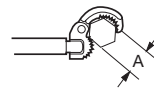

No.	A max.		L	C	kg	
	in	mm				
117010000	3/8-1.1/4	10-32	275 455	14	0,710	• 1
117480000	3/4-1.7/8	20-48	290 470	14	0,710	• 1

118 Llave de lavabo
118 Basin wrench









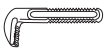

Acceso en lugares estrechos

Fijación giratoria que permite una rotación hacia izquierda y derecha.

Access to concealed spaces

Rotable claw for right and left-handed rotation.

No. Llave / wrench	in.	mm								
-----------------------	-----	----	---	---	---	---	--	---	---	---

1



102 Llave Heavy Duty / 102 Heavy duty wrench

1000001639	6	150	1300003658		70189	1000002164			
102080000	8	200	70200	70180	70190	70170			102081000
102100000	10	250	70201	70181	70191	70171			102101000
102120000	12	300	70202	70182	70192	70172			102121000
102140000	14	350	70203	102140400	102141500	70173			102141000
102180000	18	450	70204	70184	70194	70174			102181000
102240000	24	600	70205	70185	70195	70175			102241000
102360000	36	900	70206	70186	70196	70176			102361000
102480000	48	1.200	70207	70187	70197	70177			
1000001638	60	1.500	70208	1300003302	70198	1000001699			



112 Llave Heavy Duty curva / 112 Offset pattern heavy duty wrench

112100000	10	250	70201	70181	70191	70171			102101000
------------------	----	-----	-------	-------	-------	-------	--	--	-----------



104 Llave de aluminio / 104 Aluminium pipe wrench

104100000	10	250	70201	70181	70191	70171			102101000
104140000	14	350	70203	102140400	102141500	70173			102141000
104180000	18	450	70204	70184	70194	70174			102181000
104240000	24	600	70205	70185	70195	70175			102241000
104360000	36	900	70206	70186	70196	70176			102361000
70164	48	1.200	70207	70187	70197	70177			
1000001640	60	1.500	70208	1300003302	70198	1000001699			



105 Llave de aluminio curva / 104 Offset aluminium pattern wrench

105140000	14	350	105140200	102140400	102141500		102140500		
105180000	18	450	105180200	70184	70194		102180500		



101 Llave Stillson / 101 Stillson wrench

101080000	8	200	70374	101080400				101081100	102081000
101100000	10	250	70375	101100400			101100800	101101100	102101000
101120000	12	300	70376	101120400			101200800	101201100	102121000
101140000	14	350	70377	101140400			101140800	101141100	102141000
101180000	18	450	70378	101180400			101180800	101181100	102181000
101240000	24	600	70379	101240400			101240800	101241100	102241000
102360000	36	900	101360200	101360400			101360800	101361100	102361000



145 Llave Sueca "S" / 145 Swedish wrench "S"

145050000	1/2	25		143050400					
145100000	1	40		141100400					
145150000	1.1/2	55		141150400					
145200000	2	67		07211X					



145 Llave Sueca 90° / 145 Swedish wrench 90°

141100000	1	40		141100400					
141150000	1.1/2	55		141150400					
141200000	2	67		07211X					



143 Llave Sueca 45° / 145 Swedish wrench 45°

143050000	1/2	25		143050400					
143100000	1	40		141100400					
143150000	1.1/2	55		141150400					
143200000	2	67		07211X					

No. Llave / wrench	in.	mm	
-----------------------	-----	----	---



540 Tenaza pica roscas
540 Pipe thread roughing wrench

145050000	2	335	141100400
------------------	---	-----	-----------

No. Llave / wrench	Ø in. mm	
-----------------------	-------------	---



123 Llave de correa PE / 123 Strap wrench PE

123010000	20	200	123021000 (L: 110 mm)
------------------	----	-----	-----------------------



108 Llave de correa nylon / 103 Strap wrench nylon

70268	3	90	70268 (L: 435 mm)
70269	8	220	70269 (L: 950 mm)

No. Llave / wrench	Ø in. mm			
-----------------------	-------------	---	---	---



107 Llave de cadena reversible
107 Reversible chain wrench

123010000	12	300	70239 (L: 439 mm)
------------------	----	-----	-------------------



103 Llave de cadena reversible / 108 Reversible chain wrench

103300000	1.1/2	49	70262	103301200
103310000	2.1/2	77	70263	103311100 103311200
103320000	4	115	70264	103321100 103321200
103330000	6	167	70265	103331200 103331300
103340000	8	220	70266	103341200 103341300
103350000	12	325	70267	103351200 103351300

No. Llave / wrench	Ø max. in. mm	
-----------------------	------------------	---



118 Llave de lavabo / 118 Basin wrench

118010000	1.1/4	32	118010100
------------------	-------	----	-----------

Tenazas de canal ajustables

Gran capacidad de agarre, permite trabajar con una sola mano.

Indispensables en los trabajos en instalaciones y mantenimiento de tuberías, tanto para el agarre de tubos como de tuercas, perfiles ...

Tenazas dotadas de una mayor apertura de bocas pero sin aumentar la longitud de los mangos.

Cabeza y articulación pulidas.

Durezas de acuerdo a la norma DIN/UNE.

Adjusting box joint pliers

Great grip capacity, can be used with only one hand.

A must for works in pipe installation and maintenance, both for gripping tubes and nuts, sections...

Larger jaw opening with the same handle length.

Polished head and joint.

Hardness according to DIN/UNE Standards.



Fabricada en acero al cromo vanadio.

Chrome vanadium steel made.

Mangos con superficie sobredimensionada para un mayor confort y transmisión de la fuerza.

Oversized handle surface for increased comfort and force transmission.

Doble tratamiento térmico en las bocas.

Double hardened jaws.

Diferentes posiciones según las necesidades.

Different positions for different uses.

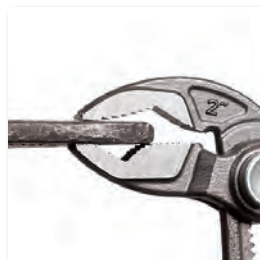

Fácil y preciso acceso a la pieza gracias al diseño de la cabeza y eje.

Easy and accurate access to the working piece thanks to the head and axis design.

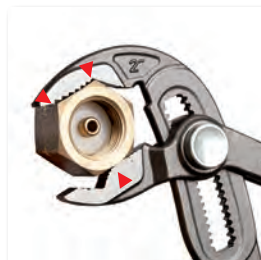

Garantiza un agarre sobre cualquier superficie, con tres puntos de apoyo.

Ensures good grip on any surface, with three contact points.

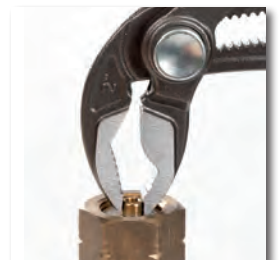

El diseño ergnómico de las bocas permite el acceso de la tenaza en lugares de difícil acceso.

Ergonomic design of the jaws to allow access to difficult places.



30% más de capacidad de agarre
con la misma longitud que las tenazas
de canal convencionales.

30% more grip capacity
with the same length as for
conventional box joint pliers.

529 Tenaza de canal autoajustable
529 Self adjusting box joint pliers

529 Tenaza de canal autoajustable

Sistema de bloqueo de seguridad: evita la apertura involuntaria y permite una regulación hasta un 50% más rápida.

Mangos plastificados.

529 Self adjusting box joint pliers

Safety lock: prevents unintentional opening, up to 50% quicker adjustment.

Plastic handles.



Sistema de bloqueo de seguridad
Safety blocking system



18 posiciones de ajuste
Adjustable in 18 positions

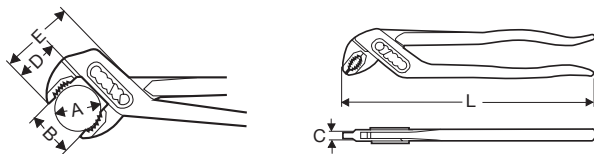

No.	L	A max.	B	C	D	E	kg			
	in mm	Ø in.	mm	mm	mm	mm				
100000660	7 175	1.1/4	35	6	27	46	0,1	•	6	
100000661	10 250	2	60	7	36	56	0,2	•	6	
Expositores de sobremesa / Desk exhibitors										
100000685	100000660 - 7" x 10 ud.									1
100000687	100000661 - 10" x 10 ud.									1

Presentaciones / Product display



528 Tenaza de canal

10 posiciones de ajuste.

2 modelos de tenazas; con o sin mangos plastificados.

528 Box joint pliers

Adjustable in 10 positions.

Two models; with or without plastic covered handles.

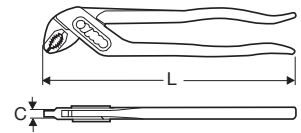
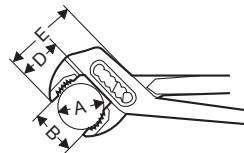

No.	L	A max.	B	C	D	E	kg			
	in mm	Ø in.	mm	mm	mm	mm				
100000668	7 175	1.1/4	35	6	27	46	0,1	•	6	
100000669	10 250	2	60	7	36	56	0,2	•	6	
Expositores de sobremesa / Desk exhibitors										
100000681	100000668 - 7" x 10 ud.									1
100000682	100000669 - 10" x 10 ud.									1
Con mangos plastificados / With plastic covered handles										
100000664	7 175	1.1/4	35	6	27	46	0,1	•	6	
100000665	10 250	2	60	7	36	56	0,2	•	6	
Expositores de sobremesa / Desk exhibitors										
100000683	100000664 - 7" x 10 ud.									1
100000684	100000665 - 10" x 10 ud.									1

Presentaciones / Product display





Herramienta profesional

para uso general, ajustable en 7 posiciones y que permite trabajar fácilmente con una sola mano

Professional tool

for general use, adjustable in 7 positions and allows working with a single hand

522 Tenaza de canal

522 Box joint pliers

**DIN 5231, 1966
UNE 16537:2006
ISO 8976:2004**

Made in Spain

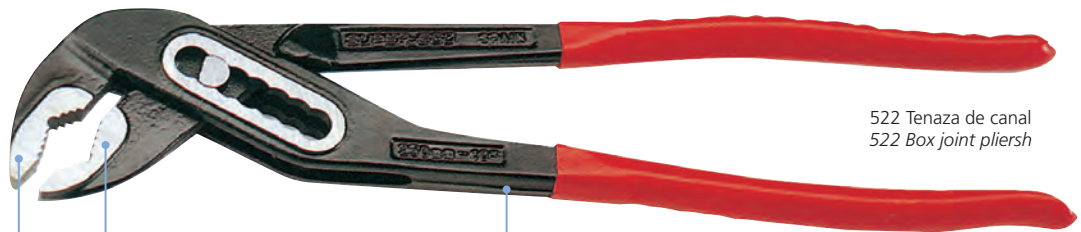

522 Tenaza de canal
522 Box joint pliersh

Las mordazas permanecen paralelas en cualquier posición, como un llave ajustable.

Jaws remain parallel in any position, sameas for an adjustable wrench.

Inducción en las bocas para aumentar la durabilidad y diseñadas para lugares de difícil acceso.

Induction in the jaws for longer durability and designed for access to difficult places.

Fabricadas en acero al cromo vanadio. Temple y revenido en el cuerpo, que mejora el rendimiento de la herramienta

Made of chrome vanadium steel. Hardened and tempered body to improve tool performance.

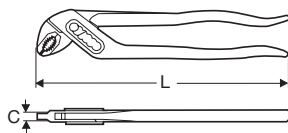
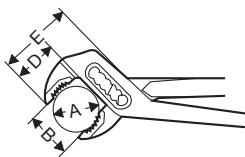

524 Tenaza de canal
524 Box joint pliersh

**522 Tenaza de canal con mangos plásticos /
522 Box joint pliers with plastic handles**

No.	L in. mm	A max. Ø in.	B mm	C mm	D mm	E mm	kg		
522070000	7 175	1	28	6	27	46	0,1	•	6
522100000	10 240	1.1/4	32	7	36	56	0,2	•	6
522120000	12 300	1.1/2	42	9	40	64	0,4	•	6

Expositor de sobremesa / Desk exhibitor

S00220000	522100000 - 10" x 12 ud.	1
-----------	--------------------------	---

524 Tenaza de canal / 524 Box joint pliers

No.	L in. mm	A max. Ø in.	B mm	C mm	D mm	E mm	kg		
520070000	7 175	1	28	6	27	46	0,1	•	6
524100000	10 240	1.1/4	32	7	36	56	0,2	•	6
524120000	12 300	1.1/2	42	9	40	64	0,4	•	6

Expositor de sobremesa / Desk exhibitor

S00210000	524100000 - 10" x 12 ud.	1
-----------	--------------------------	---

Presentaciones / Product display



527 Tenaza ajustable universal

Herramienta profesional para todos los usos. Indispensable en todas las cajas de herramientas. Indicada para montaje de muebles y herrajes, trabajos artesanos y de bricolaje, modelismo y manualidades.

Cabeza reducida con dientes endurecidos para evitar el desgaste y que aporta seguridad al agarre.

La geometría de las bocas evita que, los tubos, tuercas ..., resbalen, proporcionando una mayor seguridad.

Ajuste fino para una adaptación perfecta a los diferentes tamaños de piezas que se trabaje.

Ajuste con sólo pulsar un botón al tamaño de la pieza.

Mangos sobredimensionados que favorecen la adaptación a la mano y facilitan el trabajo.



527 Quick adjust pliers

Profesional tool for general uses. Indispensable in all tool boxes. Suitable for mounting furniture and fittings, handicraft and DIY work, model making and crafts.

Reduced head with hardened teeth to prevent wear and to increase grip safety.

Jaw geometry prevents tubes, nuts, etc. from slipping. Increased safety.

Fine adjustment for perfect fit to the workpiece.

Fit to the workpiece by just pressing a button.

Oversized handles for easy hand grip and easy work.

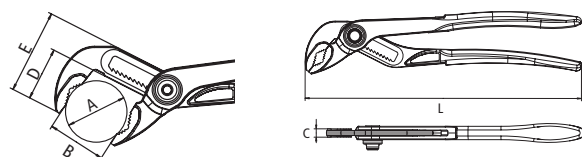
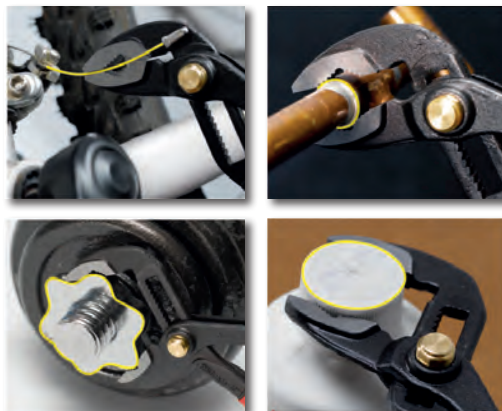

No.	L		A max.	B	C	D	E	kg	📦	📦
	in	mm								
52710P000	10	250	1.1/4	32	7,5	33	53	0,3	•	6

Presentaciones / Product display

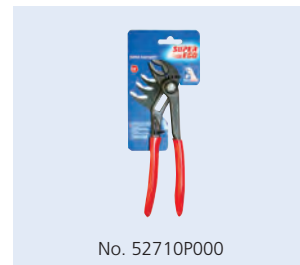

No. 52710P000

509 Tenaza de cremallera

Mordazas rectas.

Mangos plastificados.

El ángulo negativo de mecanización en la hembra impide que se desajusten los mangos.

Doble tratamiento térmico.

509 Machined groove joint pliers

Even jaws.

Plastic covered handles.

The negative machining angle of the female prevents handles from loosening.

Double tempered.

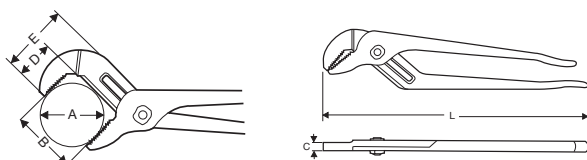
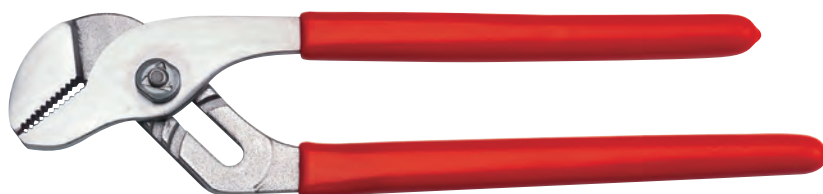

No.	L		A max.	B	C	D	E	kg	📦	📦
	in	mm								
509090000	10	250	1.1/2	37,5	9,5	29,5	52,5	0,3	•	6
509120000	12	305	2	60	8,5	38	67	0,5	•	6
509160000	16	420	4	60	12,5	64	101,5	1,3	•	6



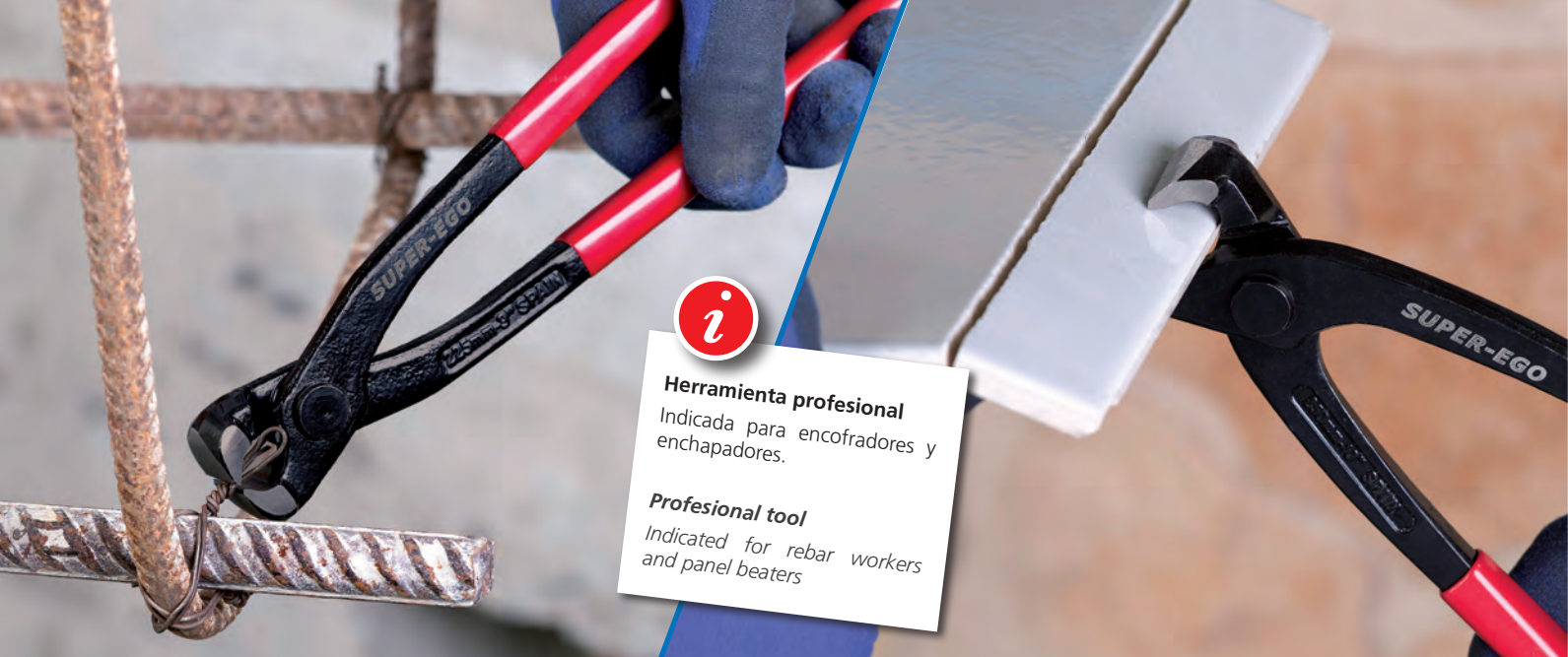

Herramienta profesional
Indicada para encofradores y enchapadores.

Professional tool
Indicated for rebar workers and panel beaters

Tenaza rusas

Completamente forjada en acero especial.
Bordes de corte afilados y templados con doble tratamientos térmico y revenido para proporcionar la dureza adecuada.
Mangos extralargos que proporcionan un amplio par y elasticidad para una acción cómoda de corte.



Presentaciones / Product display



No. 507090000

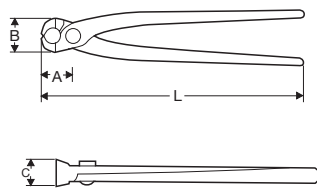

Concretor's nippers

Completely drop forged from special tool steel.
Sharp and hardened cutting edges with double heat treatment and tempering to provide the required hardness.
Extra long handles to provide a high torque and elasticity for easy cutting action.



UNE 16536:2008
ISO 8976:2004

Made in Spain

No.	L in. mm	A max. in. mm	B mm	C mm	D mm	kg		
Mangos sin plastificar / Uncoated plastic handles								
50709C000	9 225	27	30	22	36	0,3	•	6
50710C000	10 250	32	36	26	40	0,4	•	6
Con mangos plastificados / Plastic sleeves on handles.								
507090000	9 225	27	30	22	36	0,3	•	6
507100000	10 250	32	36	26	40	0,4	•	6
Expositor de sobremesa / Desk exhibitor								
500230000	507090000 - 9" x 12 ud.					3,9		1

Tenaza rusas automática

Con muelle de apertura automática para mayor manejabilidad.

Automatic concretor's nippers

With automatic opening spring for easy handling.



Presentaciones / Product display



No. 508090000

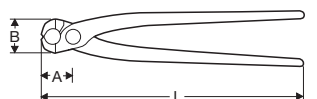

UNE 16536:2008
ISO 8976:2004

Made in Spain

No.	L in. mm	A max. in. mm	B mm	C mm	D mm	kg		
508090000	9 225	27	30	22	36	0,3	•	6
508100000	10 250	32	36	26	40	0,4	•	6

450 Tornillo de banco

Práctico tornillo de banco clásico para tubo.

Fácilmente adaptable a mesas, bancos de trabajo ... garantizando una eficaz sujeción y fácil manejo para realizar con los tubos operaciones de unión, roscado, corte

Horquilla y base de fundición nodular.

Pequeño paso de rosca que permite un agarre firme con el mínimo esfuerzo.

450 Bench yoke vise

Practical classical vice for tubes.

Easy to adapt to stands, workbenches ... ensuring an effective clamping and easy handling for tube joining, threading, cutting...operations

Nodular cast iron yoke and base.

Fine thread pitch for firm grip with minimum effort.

Presentación / Product display



No. 450020000

UNE 16536:2008
ISO 8976:2004

Made in Spain

No.	Ø		kg.	📦
	in	mm		
450020000	2	60	3,4	1
450030000	3	89	5,5	1
450040000	4	114	9,6	1

La mordaza superior flotante permite una perfecta adaptación a la forma de la tubería

Floating upper jaw allows for perfect matching the shape of the piece



400 Mordaza de cadena

Mordazas especiales de acero forjado.

Base de hierro fundido con apoyo en V.

Base diseñada para su anclaje en el banco de trabajo.

Tuerca de ajuste y apriete inferior.

Cadena de acero templado de alta resistencia y elasticidad.

400 Top screw chain vise

Special forged steel jaws.

Cast iron base with support in V. Shape support.

Base designed for fastening to work benches.

Lower adjustment and tightening nut.

Tempered steel chain of high strength and elasticity.

Presentación / Product display



No. 400020000

UNE 16-560

Made in Spain

No.	in	Ø		L mm	kg.	📦
		in	mm			
400010000	2.1/2	76	418	1,9	1	
400020000	4	114	532,0	3,9	1	
400030000	6	165	660,4	7,1	1	



404 Mordaza de cadena

Mordazas especiales en V de acero forjado, unidas en H para soporte centrado de la tubería.

Base de hierro fundido con apoyo en forma de "V" para un buen posicionamiento de la tubería.

Agarre rápido de la tubería mediante palanca lateral con excéntrica.

Base diseñada para su anclaje en mesas y bancos de trabajo.

Cadena de acero templado de gran resistencia y elasticidad.

404 Bottom screw chain vise

Special V shaped forged steel jaws, H connected for centred pipe support.

Cast iron base with V shape support.

Quick pipe grip through the chain, knurled nut screw and lateral lever with cam.

Base designed for fastening to work bench.

Tempered steel chain of high strength and elasticity.



Presentación / Product display

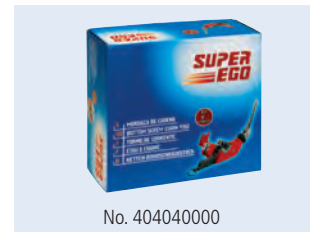

No.	Ø in	Ø mm	L mm	kg.	
404020000	2.1/2	76	418	3,4	1
404040000	4	114	570	5,5	1
404060000	6	165	762	9,6	1

462/463 Banco Tristand con placa curvatubos

Banco de trabajo plegable y portátil de fácil manipulación. La bandeja también se pliega para facilitar el transporte.

Con pata trasera regulable para mejorar la estabilidad.

Posibilidad de montar tornillos de banco y mordazas.

462/463 Tristand with bending plate

Collapsible workbench and easy handled. Collapsible tray for easy carrying

With adjustable rear leg for increased stability.

Stand accepts yoke vises and chain vises.



462

Incorpora placa curvatubos:
3/8"-1/2"-3/4"-1"-1.1/4"-1-1/2"
Pipe bending plate:
3/8"-1/2"-3/4"-1"-1.1/4"-1-1/2"

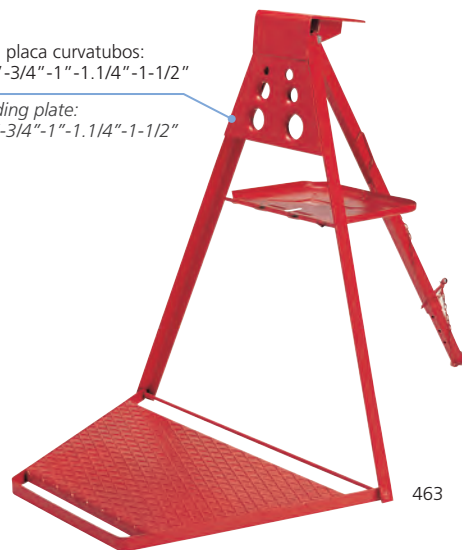

463

No.		kg.	
462000000	Banco Tristand / Tristand bench	15	1

No.		kg.	
463000000	Con placa para tubos / With pipe bending plate	16	1
463100000	463000000 + Mordaza / Bench yoke vise 450 (2")	19,4	1

464 Banco de trabajo portátil (placa de aluminio)

Banco de trabajo plegable, fabricado en aleación de aluminio de gran utilidad tanto en grandes como en pequeñas instalaciones, reparaciones o mantenimiento.

Válido para trabajar cualquier tipo de tubo.

Incluye bandeja plegable que facilita el transporte y el montaje.

Incluye ranuras para colocar herramientas, tres apoyos para doblado de tubos y alojamientos para uso de tornillos, mordazas y equipos SUPER-EGO como SUPERTRONIC® o ROBEND®.



Made in Spain

No.		kg.	
464000000	464	13	1
464003000	464 + 400 (2.1/2")	14,9	1
464003100	464 + 400 (4")	16,9	1
464003400	464 + 450 (2")	16,4	1
464020000	464 + 404 (4")	18,5	1
464030000	464 + 404 (6")	22,6	1
Tornillos para mordazas / Vise mounting			
464010100		0,2	1

Banco de trabajo 2 en 1

Banco de trabajo plegable en aluminio. Válido para trabajar cualquier tipo de tubo.

Banco muy estable que permanece perfectamente apoyado en sus tres patas, que también puede anclarse al suelo para trabajos pesados por medio de un vástago regulable al que puede unirse un tubo hasta el techo.

Incluye bandeja plegable que facilita el transporte y el montaje.

Incluye mordaza de cadena para tubos de: 10 - 150 mm / ID 1/8" - 6".

464 Portable stand (aluminium plate)

Collapsible workbench in aluminium very useful for both large and small installations, repairs or maintenance. Can be used with any kind of pipe.

Includes tray fold in for easy carrying and setup.

Includes slots for hanging tools, three pipe benders and can be used together with different vise and SUPER-EGO machines such as SUPERTRONIC® o ROBEND®



Tripod uni workbench 2 in 1

Collapsible workbench in aluminium. Can be used with any kind of pipe.

Very stable workbench resting perfectly on its three legs, which may also be anchored to the floor for heavy work by means of an adjustable stem to which a pipe reaching the ceiling can be attached.

Includes tray fold in for easy carrying and setup.

Includes chain tube vise for 10 - 150 mm / ID 1/8" - 6"



No.		kg.	
1500000530	Banco trabajo 2 en 1 / Tripod uni workbench 2 in 1	17	1



Nueva generación de cabezas de roscar que reducen el esfuerzo de roscado y tienen una mayor duración.
New threading dieheads generation. Threading effort has been reduced for a longer life.

Terrajas manuales

Terraja ligera con cabezas intercambiables y sistema de carraca oculta que permite el cambio rápido y fácil de cabezas de terraja.

Mango excéntrico de la carraca que facilita el trabajo en espacios reducidos.

Las cabezas se pueden colocar en la carraca desde ambos lados.

Peines y cabezas fabricadas con tornos CNC.

Carraca sencilla de fácil manejo y adecuada hasta 2" (1/4" a 1. 1/4" con adaptador).

Intercambiabilidad con las cabezas de terraja y de roscadoras portátiles.



Manual pipe threaders

Enclosed ratchet drop head threader and concealed ratchet system that allows quick and easy change of die heads.

Off centered handle ratchet to enable to work on confined areas.

Die heads can be placed in both sides.

Dies and die heads are CNC manufactured.

Simple and easy to use ratchet up to 2" (1/4" to 1. 1/4" with adaptor).

Interchangeability of die heads and with portable threaders.

600 Set PROMO

En caja de plástico (320 x 190 x 90 mm).

600 Set PROMO

Plastic box (320 x 190 x 90 mm).



Made in Spain

Presentación / Product display

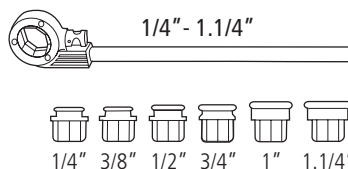

No. BSPT.	No. NPT				kg.	
600240600		1/2"-3/4"-1"-1.1/4"	1	4	5,5	1
600240900		1/2"-3/4"-1"	1	3	5,8	1
	600243900	1/2"-3/4"-1"	1	3	5,8	1

600 Set COMPACT

En caja de plástico (320 x 290 x 90 mm).

600 Set COMPACT

Plastic box (320 x 290 x 90 mm).



Made in Spain

Presentación / Product display

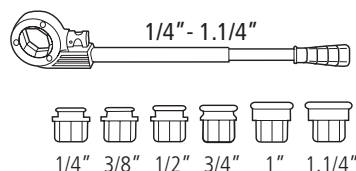

No. BSPT.	No. NPT				kg.	
600220500	600223500	3/8"-1/2"-3/4"-1"-1.1/4"	1	5	6	1
600220600	600223600	1/2"-3/4"-1"-1.1/4"	1	4	5,5	1
	600223700	1/4"-3/8"-1/2"-3/4"-1"	1	5	5,8	1
600220800	600223800	3/8"-1/2"-3/4"-1"	1	4	5,1	1
600220900	600223900	1/2"-3/4"-1"	1	3	4,6	1

600 Set PROFESIONAL

En caja de plástico (430 x 350 x 150 mm).

Presentación / Product display

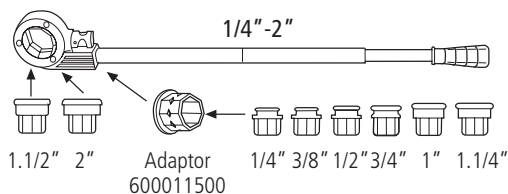

No. BSPT.	No. NPT	No. métrica					kg.	
600230000			1/4"-2"	1	8	1	12,0	1
600230100	600233100		3/8"-2"	1	7	1	11,4	1
600230200	600233200		1/2"-2"	1	6	1	10,5	1
	600233300		3/4"-2"	1	5	1	9,9	1
600230400	600233400		1"-2"	1	4	1	9,3	1
600230500			1.1/4"-2"	1	3	1	8,5	1
600230600			1.1/2"-2"	1	2	1	7,3	1
	6002M0000	16-20-25-32 mm		1	1	4	1,0	1

600 Set PROFESSIONAL

Plastic box (430 x 350 x 150 mm).



Made in Spain

500 Equipo básico del fontanero

Todas las herramientas necesarias para realizar trabajos completos de fontanería en un estuche.

En robusta caja de plástico.

500 Plumber's kit

All tools needed for a complete professional plumbing job in a single plastic book.

In robust carrying case.

No.							kg.	
500750000	14"	10"	1/4"-1.1/4" Ø	1/2-3/4-1" NPT	1/8-1.1/4"	8	1	
500630000	14"	10"	1/4"-1.1/4" Ø	1/2-3/4-1" BSPT	1/8-1.1/4"	8	1	



No. 500630000

Made in Spain

662 Terrajas ajustables 4"

Sistema de carraca (dchas) con fácil centrado del tubo para garantizar roscas perfectas.

Cuerpo abierto, facilita la caída de la viruta.

662 Adjustable Pipe threader 4"

Double ratchet system (left and right) and easy centering of the pipe, assuring a perfect threads.

Open body tipe, easy discharge of chips.

No. BSPT.	No. NPT			kg.	
662200100	662300000	1.1/2" - 4"	3	28,4	1
662200300	662300100	2.1/2" - 4"	2	27,2	1
662200500		1.1/2" - 3"	3	27,5	1
Juego de peines / Die set.					
6621D2200	6621N2200	1.1/2" - 2"			1
6622D2200	6622N2200	2.1/2" - 3"			1
6623D2200	6623N2200	3.1/2" - 4"			1

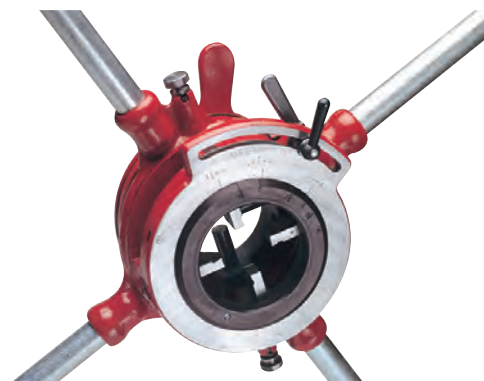

Made in Spain

Cabezas de terrajas

Para roscar tubos en rosca cónica "gas" DIN 2999 o equivalentes a derechas. Facilitan la salida de virutas proporcionando unas roscas limpias. Guías largas de los tubos para un centrado perfecto.

Made in Spain



Presentación / Product display



Die heads

For threading taper pipe threads, right-hand, "gas" DIN 2999 or equivalent. Easy swarf removal for clean threads. Long pipe guidance for perfect centering.

No. BSPT.	No. NPT	Ø	No. metric (P1,5 mm)	Ø	kg.	
6002D0000	6002N0000	1/4"	6000M1600	16 mm	0,6	1
6003D0000	6003N0000	3/8"	6000M2000	20 mm	0,6	1
6004D0000	6004N0000	1/2"	6000M2500	25 mm	0,6	1
6005D0000	6005N0000	3/4"	6000M3200	32 mm	0,6	1
6006D0000	6006N0000	1			0,8	1
6007D0000	6007N0000	1.1/4"			1,0	1
6008D0000	6008N0000	1.1/2"			1,6	1
6009D0000	6009N0000	2			1,6	1

Juego de peines

Fabricados en acero de alta calidad para una prolongada duración. La geometría del peine garantiza un primer corte fácil y un arrastre de virutas excelente

Made in Spain



Presentación / Product display



Dies set

Manufactured in high quality steel for long-lasting durability. The geometry of the die warranties an easy first cut and an excellent pulling of the metal shavings.

No. BSPT.	No. NPT	Ø	kg.		
6002D4000	6002N4000	1/4"	0,2	•	1
6003D4000	6003N4000	3/8"	0,2	•	1
6004D4000	6004N4000	1/2"	0,2	•	1
6005D4000	6005N4000	3/4"	0,2	•	1
6006D4000	6006N4000	1	0,2	•	1
6007D4000	6007N4000	1.1/4"	0,2	•	1
6008D4000	6008N4000	1.1/2"	0,4	•	1
6009D4000	6009N4000	2	0,5	•	1

Accesorios

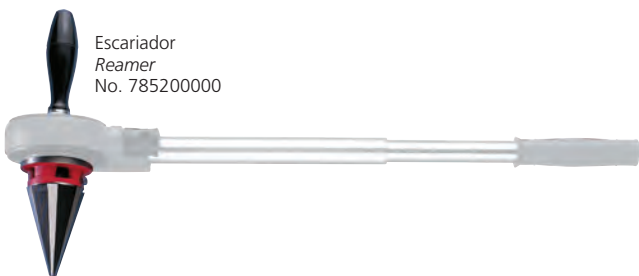

Adaptador
Adaptor
No. 600011500

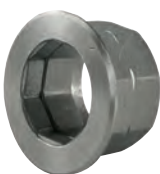

Adaptador automático
Automatic adaptor
No.862009000



Accesorios

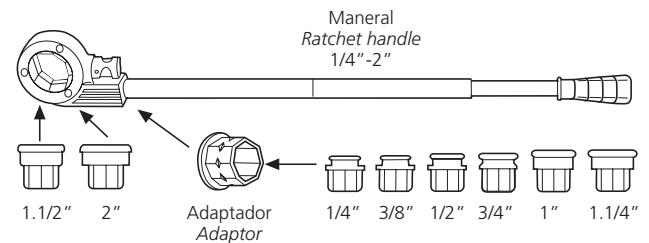

No.	kg.	
Maneral / Ratchet handle		
600000000	1/4"-1.1/4" Ø	1,70 1
600010000	1.1/2"-2" Ø	2,40 1
Escariador / Reamer only		
785200000		0,70 1
Adaptador / Adaptor		
862009000	Automático / automatic.1/4"-3/8"-1/2"-3/4"-1.1/4"	0,84 1
600011500	1/4"-3/8"-1/2"-3/4"-1.1/4"	0,30 1

SUPERTRONIC 1250

Especialmente diseñada para el trabajo de mantenimiento y usos en lugares de difícil acceso gracias a su diseño compacto en la cabeza.

La altura de la zona de roscado es la más pequeña del mercado.

Cambio de sentido de giro eléctrico para reducir el peso y maximizar la portabilidad.

Es obligatorio el uso del fijatubos de acero forjado.

Carcasa de plástico, reforzada de fibra de vidrio para proteger el motor.

Cuerpo de aluminio robusto y resistente.

Interruptor de marcha: sin bloqueo.

SUPERTRONIC 1250

Specially designed for maintenance work and use in confined spaces thanks to compact head design.

Height of threading area is the smallest in the market.

Electronic reversal of the direction of rotation to reduce weight and improve portability.

Forged steel pipe holder, recommended.

Glass reinforced plastic case to protect the motor.

Robust and resilient aluminium body.

Operating switch: non-blocking.

DATOS TECNICOS / TECHNICAL DATA

Capacidad / Capacity:	1/2" - 1.1/4"
Corriente / Current:	230V - 110V
Roscas tipo / For threading of:	BSPT - NPT
Peso / Weight:	4,9 Kg.



No. 865008700

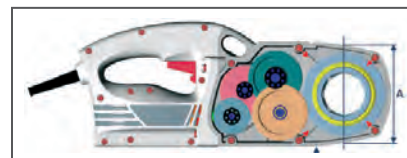

Única en el mercado con sistema de transmisión a base de engranajes helicoidales.

Only threader in the market with helicoidal gear transmission system.

No.			kg.	
865200000	1/2" - 3/4" - 1" BSPT	230 V	4,2	1
866200000	1/2" - 3/4" - 1" - 1.1/4" BSPT	230 V	4,9	1
865213000	1/2" - 3/4" - 1" NPT	110 V	4,2	1
866203000	1/2" - 3/4" - 1" - 1.1/4" NPT	230 V	4,9	1
866213000	1/2" - 3/4" - 1" - 1.1/4" NPT	110 V	4,9	1

Fijatubos / Pipe holder

865008700			1,6	1
-----------	--	--	-----	---



SUPERTRONIC 2000

Preparada para roscar tubos en rosca cónica DIN 2999 derechas.

Se recomienda el uso del fijatubos de acero forjado.

Las cabezas de 1.1/2" y 2" encajan directamente en el alojamiento octogonal.

Se necesita un adaptador con bloqueo automático para las cabezas hasta 1.1/4".

Mango integrado no deslizante.

Motor universal con doble aislamiento según las normas VDE/CEE. Reducido consumo 3,5 A.

Escobillas con acceso directo sin necesidad de apertura del motor.

Carcasa construida en aluminio aleado.

SUPERTRONIC 2000

For threading right-hand taper pipe threads DIN 2999.

Recommended forged steel pipe holder.

1.1/2" and 2" heads fit directly the octagonal housing.

Requires the Euroblock adapter for heads up to 1 1/4"

Integrated non-slip handle.

Universal electric motor with double insulation according to VDE/CEE standards. Low 3,5 A consumption.

Direct access for brush change with no need to open the motor.

Aluminium alloy case.

DATOS TECNICOS / TECHNICAL DATA

Capacidad / Capacity:	1/4" - 2"
Corriente / Current:	230V - 110V
Motor / Motor:	1.010 W 50/60 Hz
Roscas tipo / For threading of:	BSPT - NPT
Peso / Weight:	6 Kg.



Cambio de marcha mecánico, mediante palanca de inversión. En punto muerto, el motor trabaja en vacío. Gran velocidad inversa de 60 rpm que reduce el tiempo de roscado.

Mechanical reverse, direction is changed through the gear box. In neutral position the motor runs unloaded.

Cabeza de roscado desplazada y en ángulo, que permite roscar en áreas de difícil acceso y cercanas a la pared. Puede usarse sin soporte.

An offset and angled threading head enables power threading in the most confined areas and close-to-walls positions. It can be used without stand.



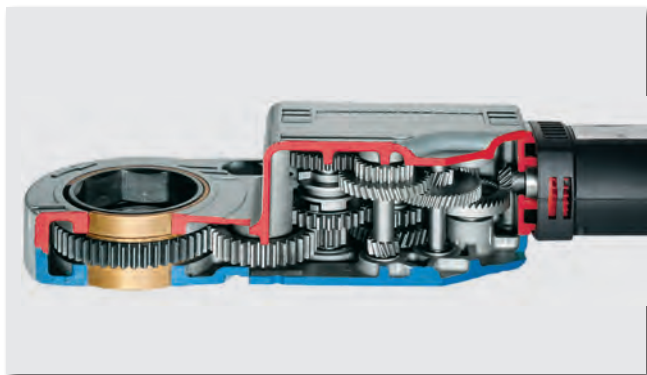

Gran reducción de la transmisión merced a su tren de engranajes con siete ejes paralelos montados sobre rodamientos de bolas, que permiten una transmisión constante del nivel de potencia.
 Reduce de 32.000 a 15-20 rpm gracias a su cadena cinemática de diseño especial, que asegura un suave rendimiento del motor.
 Lubricación constante de todos los elementos internos.

*High transmission reduction through seven parallel, ball bearing mounted gear shafts, providing constant level power transmission.
 Reduction from 32.000 to 15-20 r.p.m. is achieved through a specially designed kinematic chain ensuring a smooth motor performance.
 Constant lubrication of all the internal elements.*

Para garantizar un roscado de calidad se recomienda el uso del fijatubos de acero forjado, incluso en los tamaños pequeños. Indispensable para usar la SUPERTRONIC 2000.

For quality threads, the use of the forged steel pipe holder, even for small sizes is recommended. It is a must when using the SUPERTRONIC 2000.



Diseño ergonómico. La máquina cuenta con un asiento estable en reposo y el motor nunca toca tierra evitando así la humedad, el polvo y las roturas. Mango integrado no deslizante.

Ergonomic design. The machine at rest enjoys stable seating and the motor never touches ground, thus avoiding dampness, dust, breakage. Built-in non slip handle

Motor universal de 1010W, con doble aislamiento según las normas VDE/CEE. Reducido consumo de 3,5 A. Escobillas con acceso directo sin necesidad de la apertura del motor. La roscadora electroportatil Supertronic 2000 está avalada por certificaciones y homologaciones de calidad en diferentes países.

Universal 1010W electric motor with double insulation according to VDE/CEE standards. Low power consumption of 3,5A. Direct access to the brushes with no need for opening the motor. The electrically powered portable threader Supertronic 2000 is certified with quality approvals in several countries.

En estuche de plástico resistente que incluye: SUPERTRONIC® 2000, cabezas de terraja (según composición) y fijatubos.

Robust plastic carrying case including: SUPERTRONIC® 2000, die heads (according to composition) and pipe holder.

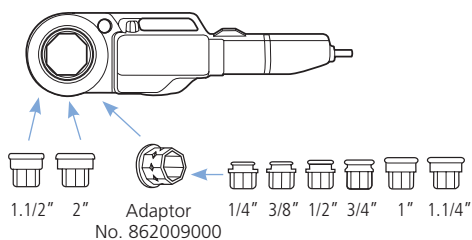

SUPERTRONIC 2000 en maleta de plástico / SUPERTRONIC 2000 in plastic box

No.			kg.	
864020000	Solamente máquina / only machine	230 V	6,8	1
864070000	Solamente máquina / only machine	110 V	6,8	1

Conjuntos SUPERTRONIC 2000 en maleta de plástico / Set SUPERTRONIC 2000 in plastic box

No. BSPT	No. NPT	No. SASO						kg.	
864220200	864223200		1/2"-2"	European - 230 V	6	1		17,5	1
864120200			1/2"-2"	European - 230 V	6		1	17,5	1
1000001626			1/2"-1.1/4"	European - 230 V	4	1		6,7	1
	864273200		1/2"-2"	American - 110 V	6	1		17,5	1
864280200	864283200		1/2"-2"	Argentine - 230 V	6	1		17,5	1
		1000000702	1/2"-2"	SASO - 220 V	6	1		17,5	1
		1000001118	1/2"-2"	SASO - 110 V	6	1		17,5	1

Fijatubos / Pipe holder

71280									1
-------	--	--	--	--	--	--	--	--	---



Máquina roscadora 2" Mod. 215

Máquina roscadora de bancada con capacidad de 1/2" a 2" (DIN 2999 BSPT dchas/NPT). Permite realizar todas las operaciones asociadas al tubo, corte, escariado y roscado en un tiempo mínimo.

Diseño ligero y compacto.

Lubricación automática por el interior de la terraja directamente a la zona de roscado.

Sistema de bloqueo-desbloqueo del cabezal de roscado.

Peines de alto rendimiento.

Cambio rápido de terrajas.

Bomba de circulación de aceite mecánica.

Threading machine 2" Mod. 215

Bed mounted threading machine with capacity for 1/2" to 2" (DIN 2999 BSPT right/NPT). Suitable for the following applications related to the pipe: cutting, reamering and threading in very short time.

Compact and light

Automatic oiling through the die head onto threading zone.

Locking-unlocking die head system.

High efficiency dies.

Quick die change.

Mechanical oil pump.

DATOS TECNICOS / TECHNICAL DATA

Capacidad / Capacity:	1/2"-2"
Roscas tipo / For threading of:	NPT - BSPT
Terraja automática / Automatic opened die head:	1/2" - 2"
Peines / Dies:	1/2"-3/4", 1"-2"
Motor de inducción monofásico: / Single phase induction motor:	900 W 50/60Hz AC
Corriente / Current:	220V / 110V
Velocidad de giro / Turn speed:	28 r.p.m.
Dimensiones / Dimensions:	800 x 600 x 600 mm
Peso / Weight:	68 kgs.

Plato de centrado posterior, permite la alineación y fijación del tubo.

Rear centering plate, allows tube alignment and fixing.

Plato delantero con garras de amarre fácilmente reemplazables.

Front plate with easy change clamping jaws.

Botón anti-salpicaduras ON/OFF

Splash proof ON/OFF button

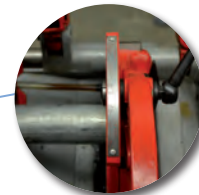

Regulación de la profundidad de la rosca para roscas más abiertas o cerradas.

Thread depth can be regulated.

Escariador de 5 aristas, de acero templado de alta resistencia.

5 flute cone reamer, made of high strength hardened steel.

Garras auto bloqueo (2 puntos de agarre por garra), fácilmente reemplazables.

Locking chucks with 2 grip points per jaw insert. Easy to replace.





Cabezal automático. Automatic die head.



Composición estándar: terraja de apertura automática de 1/2"-2", juego de peines 1/2"-3/4" BSPT, juego de peines 1"-2" BSPT, envase de aceite de corte, 3 patas de apoyo, juego de herramientas de montaje y mantenimiento en caja de madera reutilizable para transporte y almacenaje.

Standard composition: automatic die head 1/2"-2", dies set 1/2"-3/4" BSPT, dies set 1"-2" BSPT, cutting oil, 3 supporting legs, tools in reusable wood box for transport and storage.

No.		Rosca Threading		kg.	
886110000	Mod. 215	BSPT - NPT	110 V	68	1
886420000	Mod. 215	BSPT - NPT	220 V	68	1
Terraja automática / Automatic die head					
1500002157		1/2" - 2"			1



Máquina roscadora 4" Mod. 415

Máquina roscadora de bancada con capacidad de 1/2" a 4" (DIN 2999 BSPT dchas/NPT). Permite realizar todas las operaciones asociadas al tubo, corte, escariado y roscado en un tiempo mínimo.

Diseño ligero y compacto.

Lubricación automática por el interior de la terraja directamente a la zona de roscado.

Sistema de bloqueo-desbloqueo del cabezal de roscado.

Peines de alto rendimiento.

Cambio rápido de terrajas.

Bomba de circulación de aceite mecánica.

Threading machine 4" Mod. 415

Bed mounted threading machine with capacity for 1/2" to 4" (DIN 2999 BSPT right/NPT). Suitable for the following applications related to the pipe: cutting, reamering and threading in very short time.

Compact and light

Automatic oiling through the die head onto threading zone.

Locking-unlocking die head system.

High efficiency dies.

Quick die change.

Mechanical oil pump.

DATOS TECNICOS / TECHNICAL DATA

Capacidad / Capacity:	1/2" - 4"
Roscas tipo / For threading of:	NPT - BSPT
Terraja automática / Automatic opened die head:	1/2" - 2" 2.1/2" - 4"
Peines / Dies:	1/2"-3/4", 1"-2", 2.1/2"-4"
Motor de inducción monofásico: Single phase induction motor:	1.100 W 50/60Hz AC
Corriente / Current:	220V / 110V
2 velocidades / 2 speeds:	26 r.p.m. (1/2"-2") 10 r.p.m. (2.1/2"-4")
Dimensiones / Dimensions:	970 x 680 x 700 mm.
Peso / Weight:	145 kg.

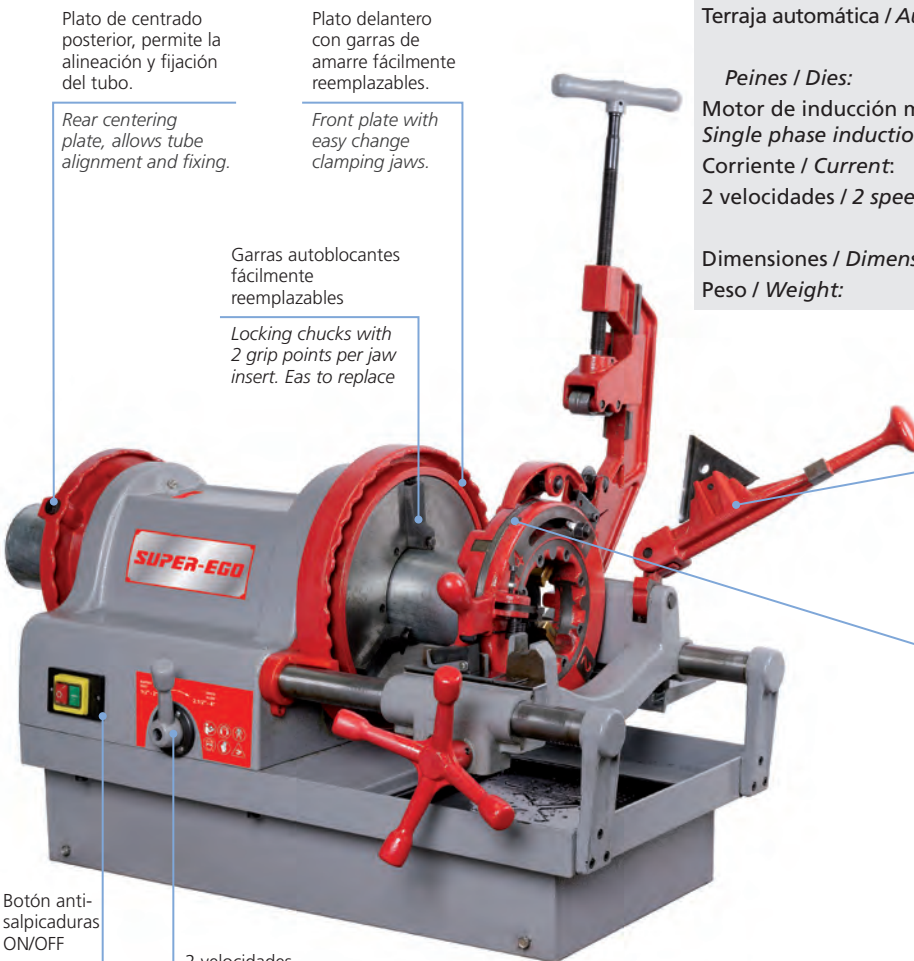

Plato de centrado posterior, permite la alineación y fijación del tubo.

Rear centering plate, allows tube alignment and fixing.

Plato delantero con garras de amarre fácilmente reemplazables.

Front plate with easy change clamping jaws.

Garras autoblocantes fácilmente reemplazables

Locking chucks with 2 grip points per jaw insert. Easy to replace

Escariador de 2 aristas, de acero templado de alta resistencia.

High strength tempered steel dual edge reamer.

Regulación de la longitud y profundidad de la rosca para roscas más abiertas o cerradas. Posibilidad de hacer roscas paralelas.

Thread length and depth regulation on more open or closed threads. Possibility for parallel threads.

Botón anti-salpicaduras ON/OFF

Splash proof ON/OFF button

2 velocidades

2 speeds:
26 r.p.m. (1/2"-2")
10 r.p.m. (2.1/2"-4")

Terraja automática: 1/2"-2"
Automatic threading die 1/2"-2"





Terraja automática: 2.1/2"-4"
Automatic threading die 2.1/2"-4"



Composición estándar: terraja de apertura automática de 1/2"-2", juego de peines 1/2"-3/4" BSPT, juego de peines 1"-2" BSPT, terraja de apertura automática de 2.1/2"-4", juego de peines 2.1/2"-4" BSPT, envase de aceite de corte, 4 patas de apoyo, juego de herramientas de montaje y mantenimiento en caja de madera reutilizable para transporte y almacenaje.

Standard composition: automatic die head 1/2"-2", dies set 1/2"-3/4" BSPT, dies set 1"-2" BSPT, automatic die head 2.1/2"-4", dies set 2.1/2"-4" BSPT, envase de aceite de corte, cutting oil, 4 supporting legs, tools in reusable wood box for transport and storage.

No.		Rosca Threading		kg.	
1500001485	Mod. 415	BSPT	110 V	145	1
1500001486	Mod. 415	BSPT	220 V	145	1
1500001589	Mod. 415	NPT	110 V	145	1
1500001591	Mod. 415	NPT	220 V	145	1
Terraja automática / Automatic die head					
1500002158		1/2" - 2"			1
1500002159		2.1/2" - 4"			1

Máquina roscadora Heavy Work 2"

Máquina roscadora con capacidad de 1/2" a 2" (DIN 2999 BSPT dchas). Ligera y compacta. Permite realizar todas las operaciones asociadas al tubo, corte, escariado y roscado en un tiempo mínimo.

Roscadora diseñada para realizar un trabajo cómodo y completamente fiable proporcionando el mejor acabado posible en el roscado de tubos.

Motor monofásico aislado según las normas VDE/CEE.

Escobillas de carbón de fácil acceso y sustitución.

Depósito de aceite herméticamente sellado para evitar pérdidas durante el transporte.

Lubricación automática y regulable por el interior de la terraja directa a los peines.

La longitud de la rosca se ajusta fácilmente modificando la posición de la leva de contacto.

Peines de alto rendimiento.

Bomba de circulación de aceite mecánica.

Threading machine Heavy Work 2"

Threading machine with capacity for 1/2" to 2" (DIN 2999 BSPT right hand). Light and compact. Allows for all tube operations, cutting, reaming and threading in minimum time.

Threader designed for easy work and completely reliable providing the best possible finish in tube threading.

Single phase insulated according to VDE/CEE standards.

Easy change graphite brushes.

Fully sealed oil tank to prevent oil losses during transport.

Automatic and adjustable direct die lubrication through the inside of the die head.

Thread length is easily adjusted by changing the position of the contact cam.

High efficiency dies.

Mechanical circulating oil pump, easily accessible for easy maintenance.

Tube diameter setting by turning the rear centering plate.

DATOS TECNICOS / TECHNICAL DATA

Capacidad / Capacity:	1/2" - 2"
Roscas tipo / For threading of:	NPT - DIN 29999 (BSPT-D)
Motor monofásico: Single-phase motor:	600 W
Corriente / Current:	220V
2 velocidades / 2 speeds:	40 r.p.m (en vacío) 27 r.p.m. (en carga)
Dimensiones / Dimensions:	590 x 375 x 395 mm.

2 platos de centrados que permiten la alineación y fijación del tubo.

2 centering plates, allows tube alignment and fixing.

Garras autoblocantes fácilmente reemplazables

Locking chucks with 2 grip points per jaw insert. Easy to replace

Botón anti-salpicaduras ON/OFF:

Botón anti-salpicaduras ON/OFF:

Se suministra con 3 patas de apoyo.

It is supplied with 3 supporting legs.

Escariador de 4 caras
4 flute cone reamer.

Composición estándar: terraja de apertura automática de 1"-2", juego de peines 1/2"-3/4" BSPT (sección 27x10mm), juego de peines 1"-2" BSPT (sección 27x10 mm), envase de aceite de corte, 3 patas de apoyo y juego de herramientas de montaje y mantenimiento.

Standard composition: automatic die head 1"-2", dies set 1/2"-3/4" BSPT (size 27 x 10 mm), dies set 1"-2" BSPT (size 27 x 10 mm), cutting oil, 3 supporting legs, tools in reusable wood box for transport and storage.

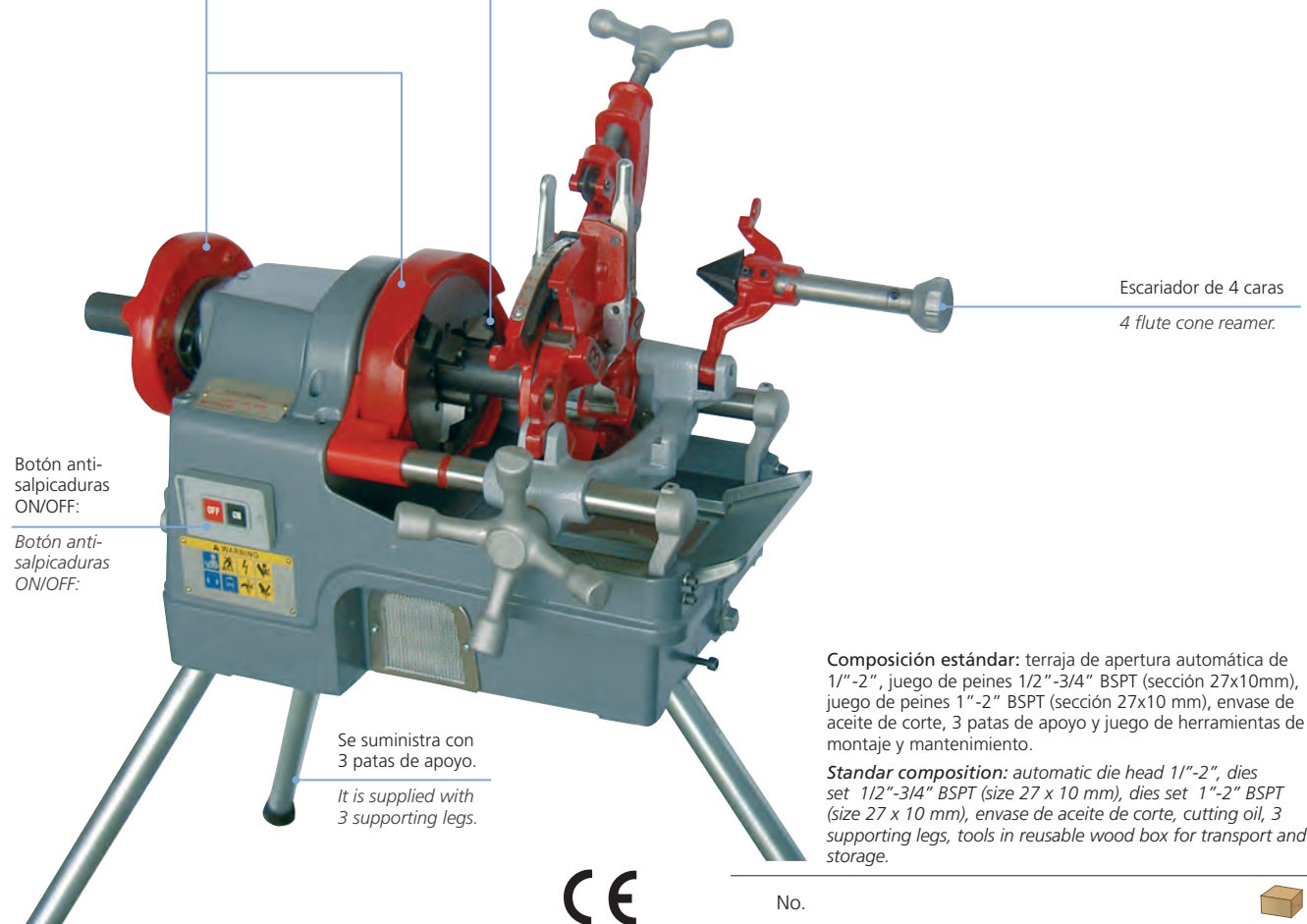

No.		Rosca Threading		kg.	
890000200	Heavy Work 2"	BSPT	220 V	46	1
8900N0200	Heavy Work 2"	NPT	220 V	46	1

No.		
890051000	Cuchilla cortatubos / Spare cutting	1
890033100	Juego de garras delanteras/ Front chuck system	1
890033900	Portagarras delanteras / Front chuck	1
890010900	Escobillas / Brushes	1
890023700	Interruptor / Switch	1

Máquina roscadora Heavy Work 4"

Máquina roscadora con capacidad de 1/4"-4" (DIN 2999 BSPT dchas). Permite realizar todas las operaciones asociadas al tubo, corte, escariado y roscado en un tiempo mínimo.

Sistema de transmisión de 3 velocidades que maximiza el trabajo, reduciendo drásticamente el tiempo empleado en la realización de roscas de cualquier medida. Sistema único de apertura de peines original que proporciona un roscado altamente preciso.

Menos de 100 segundos para realizar una rosca perfecta en un tubo de 4". Menos de 20 segundos para un tubo de 1".

Terraja de roscado de 1/2" a 2" compatible con la roscadora Heavy Work de 2".

Terraja con sistema de copiado de diseño único y original. Este sistema monta sólo 4 peines (20 mm), reduce de manera notable el consumo de energía y aumenta la velocidad de roscado (terreja de 2.1/2"-4").

Motor monofásico de condensadores altamente potente y silencioso, aislado según las normas VDE/CEE. Al no necesitar el uso de escobillas es un motor básicamente libre de mantenimiento.

Las terrajas llevan un sistema de microajuste de apertura que simplifica el ajuste fino para cada medida.

La longitud de la rosca se selecciona modificando la posición del perfil de copiado, de manera rápida y acorde a cada medida (terreja de 2.1/2"-4").

Bomba de circulación de aceite mecánica.

3 velocidades, se adaptan perfectamente a los diferentes medidas de roscado.

2 platos de centrados que permiten la alineación y fijación del tubo.

3 speeds to perfectly adapt to different thread sizes.

2 centering plates, allows tube alignment and fixing.

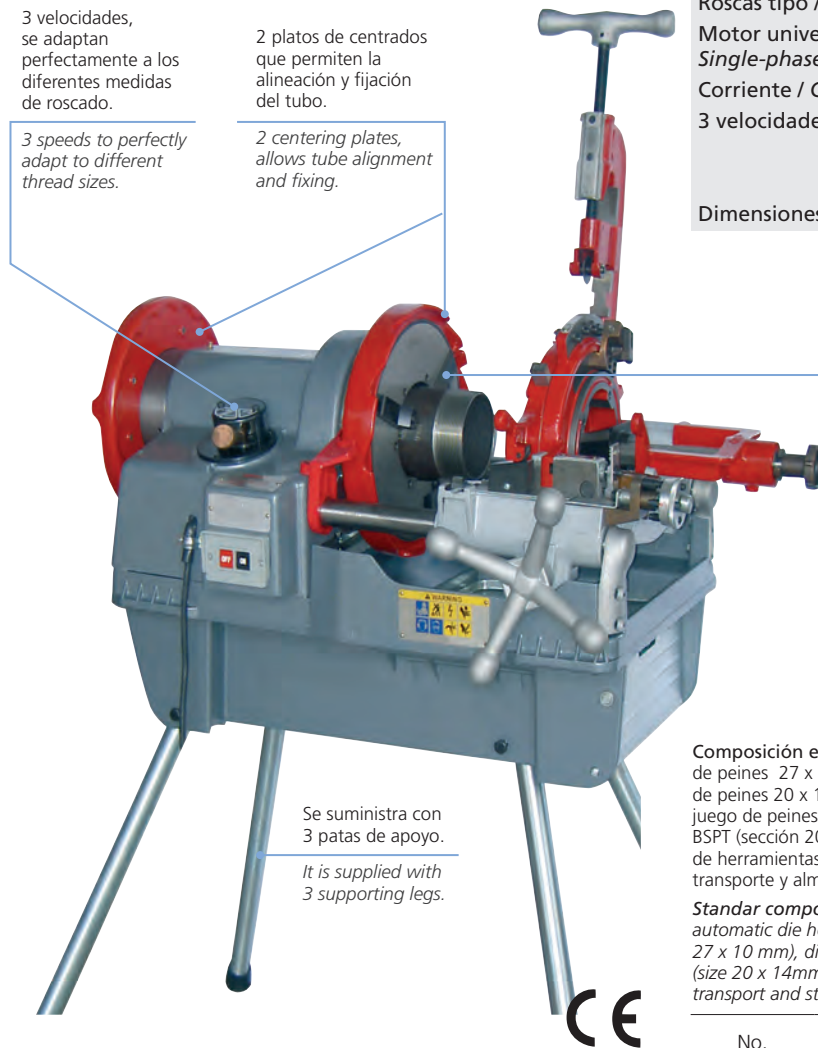

Se suministra con 3 patas de apoyo.

It is supplied with 3 supporting legs.

Threading machine Heavy Work 4"

Threading machine with capacity for 1/4"-4" (DIN 2999 BSPT right hand). Allows for all tube operations, cutting, reaming and threading in minimum time.

3 speed transmission system for maximum production, reducing drastically the threading time for any size. Unique die opening system for highly precise threading.

Less than 100 seconds for a perfect thread on a 4" pipe. Less than 20 seconds for 1" pipe.

1/2" to 2" threading die compatible with the 2" Heavy Work threader.

Die with a unique copying system. With this system, only 4 20 mm dies are mounted, which reduces significantly the power consumption and increases the threading speed.

Powerful and quiet single phase capacitor motor, insulated according to VDE/CEE standards. Since no brushes are used, the motor is basically maintenance free.

The die is provided with a micro-adjust opening system for fine adjustment of each size (Die 2.1/2"-4").

Thread length is selected by quick change of the position of the copying profile, and according to each size.

Mechanical oil circulation pump.

DATOS TECNICOS / TECHNICAL DATA



Capacidad / Capacity:	1/4 - 4"
Roscas tipo / For threading of:	NPT - DIN 29999 (BSPT-D)
Motor universal monofásico: Single-phase universal motor:	1.280 W 50/60 Hz
Corriente / Current:	220V / 110V
3 velocidades / 3 speeds:	48 r.p.m (1/2"-3/4") 17 r.p.m. (1"-2") 15 r.p.m. (2.1/2"-4")
Dimensiones / Dimensions:	873 x 635 x 558 mm.

Garras autoblocantes fácilmente reemplazables

Locking chucks. Easy to replace.

Composición estándar: terraja de apertura automática de 1/2"-2" (sección de peines 27 x 10 mm), terraja de apertura automática de 2.1/2"-4" (sección de peines 20 x 14 mm), juego de peines 1/2"-3/4" BSPT (sección 27 x 10 mm), juego de peines 1"-2" BSPT (sección 27 x 10 mm), juego de peines 2.1/2"-4" BSPT (sección 20 x 14mm), envase de aceite de corte, 4 patas de apoyo, juego de herramientas de montaje y mantenimiento y caja de madera reutilizable para transporte y almacenaje.

Standar composition: automatic die head de 1/2"-2" (size 27 x 10 mm), automatic die head 2.1/2"-4" (size 20 x 14 mm), dies set 1/2"-3/4" BSPT (size 27 x 10 mm), dies set 1"-2" BSPT (size 27x10 mm), dies set 2.1/2"-4" BSPT (size 20 x 14mm), cutting oil, 4 supporting legs, tools in reusable wood box for transport and storage.

No.	Rosca Threading		kg.		
891000400	Heavy Work 4"	BSPT	110 - 220 V	123	1
8910N0400	Heavy Work 4"	NPT	110 - 220 V	123	1

No.		
897072800	Cuchilla cortatubos / Spare cutting	1
894026900	Juego de garras delanteras/ Front chuck system	1
897030900	Portagarras delanteras / Front chuck	1
897035900	Interruptor / Switch	1

Juegos de peines

Fabricados en acero de alta calidad para una prolongada duración. La geometría del peine garantiza un primer corte fácil y un arrastre de virutas excelente.

Set of dies

Made of high quality steel for longer life. Die geometry ensures an easy first cut and excellent swarf removal.



Para roscadora Mod. 215-2" y Mod. 415-4" / For Mod. 215-2" & Mod. 415-4"

No.			
1/2" - 3/4"	Sección / Section 27 x 9,5 mm		
886427000	BSPT 4 peines / 4 dies	1	
886428000	NPT 4 peines / 4 dies	1	
1" - 2"	Sección / Section 27 x 9,5 mm		
886427100	BSPT 4 peines / 4 dies	1	
886428100	NPT 4 peines / 4 dies	1	
2.1/2"-4"	Sección / Section 22,20 x 15,80 mm		
1000001450	BSPT 4 peines / 4 dies	1	
1000001452	BSPT HSS 4 peines / 4 dies	1	
1000001451	NPT 4 peines / 4 dies	1	
1000001453	NPT HSS 4 peines / 4 dies	1	

Para roscadora Heavy Work 2" y 4" / For threading machine Heavy Work 2" & 4"

No.			
1/2" - 3/4"	Sección / Section 27 x 10 mm		
891060200	BSPT 4 peines / 4 dies	1	
891060597	NPT 4 peines / 4 dies	1	
1" - 2"	Sección / Section 27 x 10 mm		
881060100	BSPT 4 peines / 4 dies	1	
881060397	NPT 4 peines / 4 dies	1	
2.1/2"-4"	Sección / Section 22,20 x 15,80 mm		
894070697	BSPT 4 peines / 4 dies	1	
894070897	BSPT HSS 4 peines / 4 dies	1	

Soporte para tubos 4"

Indispensable para un roscado cómodo del tubo. Regulable en altura. Hasta 4". Alojamiento para el tubo en forma de "V" con bolas para un perfecto deslizamiento.



Support for pipes up to 4"

A must for easy tube threading. Adjustable in height. Up to 4". "V" shape tube holder with balls for perfect sliding.

No.		
899600000	Soporte para tubos / Support for pipes up to 4"	1

Aceite de roscar

Roscado continuo con lubricación y refrigeración óptimos. Reduce el desgaste de las herramientas. Facilita la eliminación de viruta. Previene la oxidación. Totalmente inocuo para la piel. Indispensable para el uso de su máquina roscadora.

Cutting oil

Continuous threading with optimum lubrication and cooling. Reduces tool wear. Makes swarf removal easier. Prevents corrosion. Totally harmless for the skin. Essential for your threading machine.



No.		kg.	
899100100	Aceite mineral. Mineral oil. Spray 600 ml.	0,6	1
SEH020600	Aceite mineral. Mineral oil 5 L.	5	1
899200100	Aceite sintético. Sintetic oil. Spray 600 ml.	0,6	1
SEH020200	Aceite sintético. Sintetic oil 5L.	5	1

Accesorio RO-GROOVER

Máquina manejable, ligera, y robusta que permite hacer ranuras en tubos de hasta 6" (sch 10) y hasta 3" (sch 40) con suma facilidad.

Altamente versátil gracias a los múltiples accesorios de que dispone, puede ser utilizada junto con máquinas roscadoras de marcas como SUPER-EGO, ROTHENBERGER y usada junto a nuestra roscadora SUPERTRONIC® y un gran número de posibles bases de sujeción (bancos de trabajo 464, y junto a cualquier tornillo de banco).

El ajuste de la profundidad de ranurado en función del tubo utilizado es muy sencillo, existiendo diferentes rodillos en función del diámetro del tubo a ranurar.

Set básicos con capacidad de 2" - 6" (sch 10), conjuntos opcionales de rodillos 1" y conjuntos de rodillos de 1.1/4" y 1.1/2".

DATOS TECNICOS / TECHNICAL DATA

Capacidad / Capacity: **6" (sch 10)**

3" (sch 40)

Peso / Weight:

14,5 Kg.

Accessory RO-GROOVER

Easy to handle, light, and robust machine for easy pipe grooving up to 6" (sch 10) and 3" (sch 40).

Highly versatile thanks to the various accessories provided, it may be used jointly with threading machines of different brands such as SUPER-EGO, ROTHENBERGER, RIDGID and with our SUPERTRONIC® threader and a variety of stands (work bench 464, and any bench vise).

Grooving depth is easily adjusted for each pipe size, different rolls being provided as a function of the size of the pipe to be grooved.

Basic sets with capacity 2"-6" SCH 10. Optional sets of rolls 1" and sets of rolls 1.1/4" and 1.1/2".



Accesorios para tubos ranurados.

Accesorios para tubos ranurados.

Made in Spain

No.		kg.	
887090100	Para / for SUPER-EGO, ROTHENBERGER, REX 3"	14,5	1
887090200	Para / for SUPER-EGO, REX 2"	14,5	1
887090800	Para / for SUPER-EGO 4"	14,5	1
887092000	Para / for SUPERTRONIC® 2000	14,5	1
Rodillo y eje de ranurado / Grooving roll and shank			
887090500	1"		
887090600	1.1/4"-1.1/2"		
887090700	2"-6"		
Base de montaje de repuesto / Spare stand			
887090300	SUPER-EGO 3"		
887091800	ROTHENBERGER 4"		
887092100	SUPERTRONIC® 2000		



ROGROOVER 2 - 12"

Ranuradora electrohidráulica para el ranurado rápido de tubos de acero de 2"-12" (60-325 mm) con paredes estandar y finas. Para la instalación de tuberías, sistemas antincendios, instalaciones de calefacción, industria y minería.

Bomba hidráulica robusta con agarres de forma precisa para un manejo ideal.

Compacta pero muy estable.

Motor potente pero silencioso.

Ajuste fino de la profundidad de la ranura.



Ajuste fino de la profundidad de la ranura, resultados óptimos.

Fine adjustment of the groove depth and regulation, for optimum results.

Bomba hidráulica robusta con agarres de forma precisa, manejo ideal

Sturdy hydraulic-pump with precisely formed grips, for ideal handling

Motor potente pero silencioso

Powerful yet quiet motor

Compacta pero muy estable, funcionamiento seguro

Compact and very stable machine design, safe operation

Cinta métrica incluida

Diameter measuring tape, included

La entrega incluye: ROGROOVER 2 - 12", set de rodillos de 2-6", set de rodillos de 3-6", set de rodillos de 8-12", soporte para tubos, herramientas para la instalación, cinta para medir el diámetro, CD de instrucciones e instalación en caja de madera reutilizable para transporte y almacenaje.

Scope of delivery: ROGROOVER 2 - 12", roll groove set 2-6", roll groove set 3-6", roll groove set 8-12", pipe support stand, tools for installation, diameter measuring tape, installaton and instructional CD in reusable wood box for transport and storage.

No.			kg.	
1500001987	EU	230V 50Hz	129	1
1500001988	USA	110V 60 Hz	129	1
1500002073	SASO	230V 50/60 Hz	129	1

ROGROOVER 2 - 12"

Electro-hydraulic rolling groover for steel pipes 2"-12" (60-325 mm) for rolling of grooves on thin-walled and standard steel pipes. Sprinkler systems, installations, larger heading units, industrial use and mining.

Sturdy hydraulic-pump with precisely formed grips for ideal handling.

Compact and very stable machine design

Powerful yet quiet motor.

Fine adjustment for groove depth and regulation.

DATOS TECNICOS / TECHNICAL DATA

Rango de trabajo / Working range: 2 - 12" (60 - 325 mm)

Grosor de pared del tubo / Pipe wall-thickness: 3 - 10 mm

Corriente / Current: 230 / 240 V, 50 / 60 Hz

Potencia / Power: 1.100 W

Velocidad / Speed: 23 U/min

Máx. presión de trabajo / Max. working pressure: 8 kg

Dimensiones / Dimensions: 920 x 460 x 960 mm

Peso / Weight: 129 kg

Válvula de suministro, modificaciones de aplicación rápida

Pressure valve, quick application modifications

Estabilizador para tubos grandes, el tubo no se resbala

Stabilizer for large pipes, no slipping of the pipe

No.



Conjunto rodillo superior e inferior / Roll Groove set

887307000	2"-8"	1
887308000	3"-8"	1
887309000	8"-12"	1

Soporte para tubo / Pipe support stand

1500000233	1
------------	---

Cortatubos MINI PRO 716 y 722

Para cortar con precisión tubos de cobre, latón, aluminio y acero inoxidable (diferentes cuchillas).

Cuerpo compacto y corredera de pequeñas dimensiones para trabajos en espacios muy reducidos. Cuerpo reforzado en su base.

Rodillos con alojamientos para tubos abocinados.

DATOS TECNICOS / TECHNICAL DATA

Capacidad / Capacity:

MINI PRO 716 **3-16 mm (1/8"-5/8")**

MINI PRO 722 **6-22 mm (1/4"-7/8")**

Aplicación / Application: **Cu-Al, SS (Inox)**

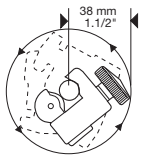

No. 716200000

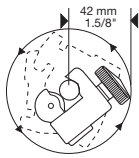

No. 722200000

Made in Spain

No.	⊗	in	mm	kg			
716200000	1 x Cu-Al	1/8-5/8	3-16	0,1	•	4	
722200000	1 x Cu-Al	1/4-7/8	6-22	0,1	•	4	
Expositor de sobremesa / Desk exhibitor							
P002D0300	716200000 x 20 ud. + 722200000 x 20 ud.						1
Cuchillas / Cutter wheels							
735000500	5 uds. Cu-Al						1
735001500	5 uds. SS (Inox)						1
Eje / Shaft							
70041							1

Tube cutter MINI PRO 716 and 722

For precise cutting of copper, brass, aluminium and stainless steel (different wheels).

Compact body and small cutter-slide for work in confined spaces. Reinforced base.

Flaring pipes cut grooved rollers.



No. 716200000



No. 722200000

Presentación / Product display



No. 716200000



No. 722200000



No. P002D0300

Cortatubos MINICUT 7221 y MINI-MAX PRO 728

Para cortar con precisión tubos de cobre, latón, aluminio y acero inoxidable (diferentes cuchillas).

Cortatubos compacto de gran capacidad y de pequeño radio de giro que permite el trabajo en espacios reducidos.

Diseño ergonómico que aumenta la superficie de apoyo para los dedos y mejora su manipulación.

Mejora de la precisión de corte gracias al sólido bastidor y reducida tolerancia de deslizamiento. Rodillos extra largos.

DATOS TECNICOS / TECHNICAL DATA

Capacidad / Capacity:

MINICUT 7221 **6-22 mm (1/4-7/8")**

MINI-MAX PRO 728 **3-28 mm (1/8"-1.1/8")**

Aplicación / Application: **Cu-Al, SS (Inox), MLP**



No. 722100000

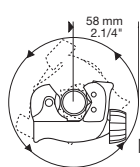

No. 728000000

Made in Spain

No.	⊗	in	mm	kg			
722100000	1 x Cu-Al	1/4-7/8	6-22	0,2	•	4	
728000000	1 x Cu-Al	1/8-1.1/8	3-28	0,2	•	4	
Cuchillas / Cutter wheels							
735000500	5 uds. Cu-Al						1
735001500	5 uds. MLP						1
735001500	5 uds. SS (Inox)						1
Eje / Shaft							
70041							1

Tube cutter MINICUT 7221 and MINI-MAX PRO 728

For precise cutting of copper, brass, aluminium and stainless steel (different wheels).

High capacity compact tube cutter and small cutter-slide for work in confined spaces.

Ergonomic design of body and knob provides better hand grip for turning.

Better cut precision thanks to the sturdy frame and small slip tolerance. Extra long rollers.



No. 722100000



No. 728000000

Presentación / Product display



No. 722100000



No. 728000000

Cortatubos estándar PRO 725

Para cortar con precisión tubos de cobre, latón, aluminio y acero inoxidable (diferentes cuchillas).

- Escariador plegable.
- Cuerpo y corredera de aleación Zamak.
- Guía monobloque.
- Rodillos con alojamiento para corte cerca del abocardado.
- El pomo incorpora cuchilla de repuesto en alojamiento específico.
- Pomo de diseño especial para un mejor agarre.



Presentación / Product display



Standard tube cutter PRO 725

For precise cutting of copper, brass, aluminium and stainless steel (different wheels).

- Retractable internal deburrer.
- Zamak body and cutter-slide.
- Monoblock guide.
- Flaring pipes cut grooved rollers.
- Spare cutter wheel in specific knob housing.
- Special knob design for better grip.

DATOS TECNICOS / TECHNICAL DATA

Capacidad / Capacity: **3-30 mm (1/8"-1.1/8")**
 Aplicación / Application: **Cu-Al, MLP, SS (Inox)**



No.			in	mm	kg		
725200000	2 x Cu, Al		1/8-1.1/8	3-30	0,2	•	4
Cuchillas / Cutter wheels							
735000500		5 uds.		Cu-Al			1
735010500		5 uds.		MLP			1
735001500		5 uds.		SS (Inox)			1
763012200		5 uds.		PP, PE			1
Eje / Shaft							
70041							1

Cortatubos PRO 726

Para cortar con precisión tubos de cobre, latón, aluminio y acero inoxidable (diferentes cuchillas).

- Escariador plegable.
- Cuerpo y corredera de aleación Zamak.
- Guía monobloque.
- Rodillos con alojamiento para corte cerca del abocardado.
- El pomo incorpora cuchilla de repuesto en alojamiento específico.
- Con tope de rodillos para protección de la cuchilla.
- La perpendicularidad entre rodillos y cuchilla produce un corte preciso.



Presentación / Product display



Tube cutter PRO 726

For precise cutting of copper, brass, aluminium and stainless steel (different wheels).

- Retractable internal deburrer.
- Zamak body and cutter-slide.
- Monoblock guide.
- Flaring pipes cut grooved rollers.
- Spare cutter wheel in specific knob housing.
- Roller stops for cutter wheel protection.
- The squareness of the rollers to the cutter wheel produces a sharp and clean cut.

DATOS TECNICOS / TECHNICAL DATA

Capacidad / Capacity: **12-50 mm (1/2"-2")**
 Aplicación / Application: **Cu-Al, MLP, SS (Inox)**



No.			in	mm	kg		
726000000	2 x Cu-Al		1/2-2	12-50	0,5	•	4
726020000	1 CU, Al+1 PP, PE		1/2-2	12-50	0,5	•	4
Cuchillas / Cutter wheels							
735000500		5 uds.		Cu-Al			1
735010500		5 uds.		MLP			1
735001500		5 uds.		SS (Inox)			1
763012200		5 uds.		PP, PE			1
Eje / Shaft							
70006							1

Cortatubos 735-742

Cortatubos profesional de ajuste rápido indicado para instalación y mantenimiento de fontanería, calefacción y aire acondicionado, así como en la industria en general.

Diseñado y fabricado especialmente para cortes fáciles y rápidos. Ajuste rápido. Fácil de utilizar con el mínimo esfuerzo.

Sistema telescópico de alimentación de cuchilla.

Telescopic cutter wheel feed system.

Rodillos con alojamiento válido para el corte del tubo abocinado.

Close-to-flare cut grooved rollers.

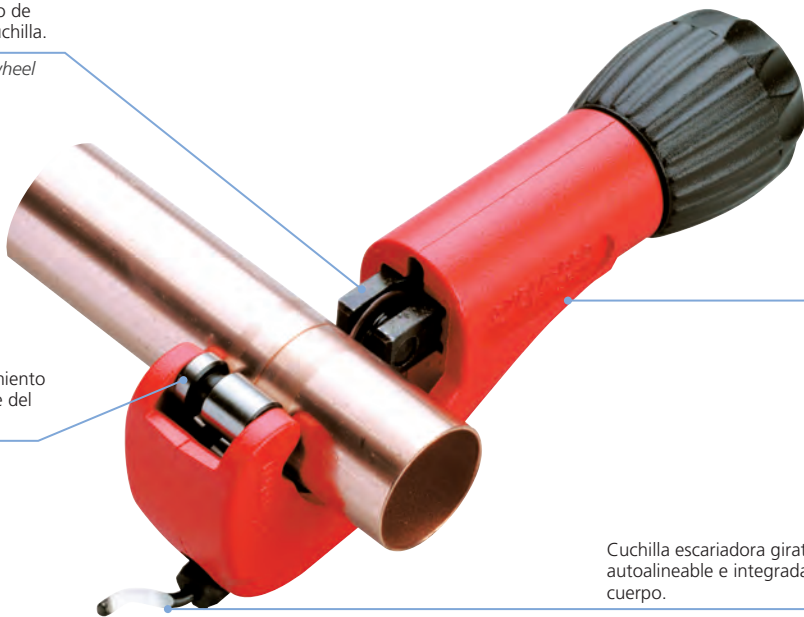

Pomo sobredimensionado para un fácil agarre. Con cuchilla de repuesto en el pomo.

Oversized knob for easy grip. With spare cutter wheel in knob.

Fabricado en Zamak.
Made of Zamak.

Cuchilla escariadora giratoria, autoalineable e integrada en el cuerpo.

Rotary reaming blade, self aligning and integral in the body.

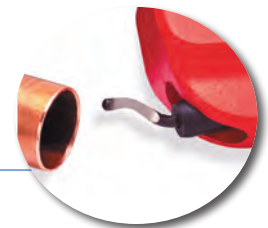

Cortatubos 735 / Tube cutter 735

DATOS TECNICOS / TECHNICAL DATA

Capacidad / Capacity: **6-35 mm (1/4"-1.3/8")**
 Aplicación / Application: **Cu-Al, Inox, MLP, SS (Inox)**



No.	⊗	↔ in	↔ mm	kg		
735000000	2 x Cu-Al	1/4-1.3/8	6-35	0,2	•	4
Gris EPOXY / Grey EPOXY						
735050000	2 x Inox	1/4-1.3/8	6-35	0,2	•	4
Cuchillas / Cutter wheels						
735000500			5 uds. Cu-Al			1
735010500			5 uds. MLP			1
735001500			5 uds. SS (Inox)			1
763012200			5 uds. PP, PE			1
Cuchilla escariadora / Revolving deburrer						
21652			Cu-Al			1
735002300			SS (Inox)			1
Eje / Shaft						
70041						1

Presentación / Product display

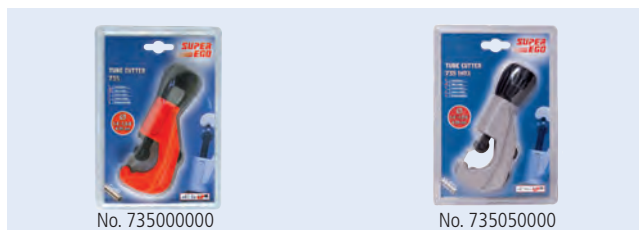

Tube cutter 735-742

Professional cutter designed for quick cuts ideal for plumbing, heating and air conditioning installation and maintenance operations, as well as industry in general.

Specially designed for easy and quick cuts. Quick adjust. Easy to use with minimum effort.

Cortatubos 742 / Tube cutter 742

DATOS TECNICOS / TECHNICAL DATA

Capacidad / Capacity: **6-42 mm (1/4"-1.5/8")**
 Aplicación / Application: **Cu-Al, MLP, SS (Inox)**



No.	⊗	↔ in	↔ mm	kg		
742000000	2 x Cu-Al	1/4-1.5/8	6-42	0,2	•	4
74200ZB00	2 x Cu-Al, 1x Inox, 1 x MLP	1/4-1.5/8	6-42	0,2	•	4
Cuchillas / Cutter wheels						
735000500			5 uds. Cu-Al			1
735010500			5 uds. MLP			1
735001500			5 uds. SS (Inox)			1
763012200			5 uds. PP, PE			1

Presentación / Product display

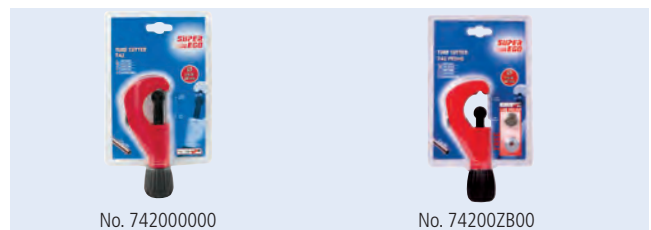

Cortatubos automático

Cortatubos indicados para el corte de tubería de plástico.

El sistema automático permite ajustar la acción deslizante y una rápida liberación de la misma.

Cuerpo de aluminio reforzado y corredera con tope para proteger las cuchillas.

Pomo de diseño ergonómico. Escariador independiente con cuchilla escariadora giratoria y alojado en el cuerpo del cortatubos.

Automatic tube cutter

Tube cutter indicated to cut plastic pipes

Automatic system for adjusting the cutter-slide action and quick release.

Reinforced aluminium monoblock body and slide bar with stop for cutter wheel protection.

Ergonomic handle. Separate reamer with rotary reaming blade housed into the tube cutter body.

Cortatubos automático 750



Presentación / Product display



4 rodillos extralargos con alojamientos para tubos abocinados.

4 extra long close-to-flare cut grooved rollers and ergonomic knob.

No. 750000000

Automatic tube cutter 750

DATOS TECNICOS / TECHNICAL DATA

Capacidad / Capacity: **6-67 mm (1/4"-2.5/8")**
 Aplicación / Application: **Cu-Al, PP-PE, MLP**

Made in Spain

No.				kg		
750000000	2 x Cu, Al	1/4-2.5/8	6-67	0,7	•	1
750010000	2 x PP, PE	1/4-2.5/8	6-67	0,7	•	1
Cuchillas / Cutter wheels						
735000500		5 uds. Cu-Al				1
735010500		5 uds. MLP				1
763012200		5 uds. PP, PE				1
Eje / Shaft						
70042						1
Cuchilla escariadora / Revolving deburrer						
751004100						1

Cortatubos automático 751/752



Presentación / Product display

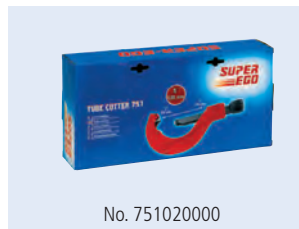

2 rodillos extralargos con alojamientos para tubos abocinados.

2 extra long close-to-flare cut grooved rollers and ergonomic knob.

No. 751020000

Automatic tube cutter 751/752

DATOS TECNICOS / TECHNICAL DATA

Capacidad / Capacity:
 Cortatubos automático 751 **50-127 mm (2"-5")**
 Cortatubos automático 752 **100-168 mm (4"-6.5/8")**
 Aplicación / Application: **Cu-Al, PP-PE, MLP**

No.					kg		
751020000	PP, PE	2-5	50-127	8,6	2,0	•	1
751010000	PP, PE	2-5	50-127	13	2,0	•	1
751000000	Cu, Al	2-5	50-127	-	2,0	•	1
752030000	PP, PE	4-6.5/8	100-168	16	2,4	•	1
Cuchillas / Cutter wheels							
737000500		8 uds. Cu-Al					1
737012200		8 uds. PP, PE 40 Ø					1
737032200		8 uds. PP, PE 30,5 Ø					1
738012200		8 uds. PP, PE 45 Ø					1
Eje / Shaft							
70042							1
Cuchilla escariadora / Revolving deburrer							
751004100							1

Escariador interno/externo

Escariador rápido y sin esfuerzo de tubos de cobre, acero y acero inoxidable de Ø 4-40 mm (1/8-1.5/8").

Proporciona un escariado fino y preciso

Permite un gran ahorro de tiempo

NUEVO
NEW



Internal/external deburrer

Quick and easy deburring Ø 4-40 mm (1/8-1.5/8") for copper, steel and stainless steel pipes.

Precise, burr-free deburring without effort.

No.	
1500002738	Escariador interno/externo / Internal/external deburrer

Cortatubos para hierro 701

Para corte de precisión de tubos de acero y fundición.

Cuerpo forjado de acero especial.

Barra de ajuste con dos áreas moleteadas para avance y retroceso rápido de la corredera.

DATOS TECNICOS / TECHNICAL DATA

Capacidad / Capacity:

701010000 10-31 mm (1/8" -1.1/4")

701020000 10-60 mm (1/8"-2")

Aplicación / Application: Fe

Steel pipe cutter 701

Steel and cast iron precision cuts.

Forged special steel body.

Adjusting bar with two knurled areas for quick cutter-slide feed and release.



No.	⊙	in	mm	kg		
701010000	Fe	1/8 - 1.1/4	10-31	1,1	•	1
701020000	Fe	1/8-2	10-60	2,4	•	1
Cuchillas / Cutter wheels						
701010500		5 uds. Fe 1.1/4"				1
Eje / Shaft						
701011500		1.1/4"				1

Presentación / Product display



Cortatubos para hierro 710

Para corte de precisión de tubos de acero y fundición.

Cuerpo forjado de acero especial.

Barra de ajuste con dos áreas moleteadas para avance y retroceso rápido de la corredera.

Dispone de un práctico mango adicional que facilita el trabajo de corte.

DATOS TECNICOS / TECHNICAL DATA

Capacidad / Capacity: 60-115 mm (2"-4")

Aplicación / Application: Fe

Steel pipe cutter 710

Steel and cast iron precision cuts.

Forged special steel body.

Adjusting bar with two knurled areas for quick cutter-slide feed and release.

Includes a practical additional handle for easy cutting.



No.	⊙	in	mm	kg		
710040000	Fe	2 - 4	60-115	7,2	•	1
Cuchillas / Cutter wheels						
710020500		5 uds. Fe 2"				1
710040500		3 uds. Fe 4"				1
Eje / Shaft						
70053		2"				1
70064		4"				1

Presentación / Product display



Tijera para tubo de plástico Ø 26 mm

Para el corte de tubos de plástico: PP, PE, PEX, PVC, PB, PVDF.
Con capacidad de 1" (26 mm.)

Fabricada en plástico con fibra de vidrio, ligera y robusta.

Diseño ergonómico.

Cuchilla fabricada en acero inoxidable en forma de V.

Cierre de seguridad.



Presentación / Product display



No. 568060000

Plastic pipe shears Ø 26 mm

For precise cutting of plastic pipes: PP, PE, PEX, PVC, PB, PVDF.
Capacity of 1" (26 mm.)

Made of light and robust glass-reinforced plastic.

Ergonomic design.

Stainless steel V-shaped blade.

Safety locking hood.

DATOS TECNICOS / TECHNICAL DATA

Capacidad / Capacity: **0-26 mm (0 -1")**
Aplicación / Application: **PP, PE, PEX, PVC, PB, PVDF**

Made in Spain

No.	in	mm	kg		
568060000	0-1	0-26	0,1	•	4

Tijera para tubo de plástico Ø 32 mm

Para el corte de tubos de plástico: PP, PE, PEX, PVC, PB, PVDF.
Con capacidad de 1.1/4" (32 mm.)

Fabricada con aluminio de primera fusión, confiere una gran ligereza y robustez. Diseño ergonómico.

Cuchilla intercambiable en forma plana de acero inoxidable.

Cierre de seguridad.

"TURN & CUT", sistema que permite girar y cortar alrededor del tubo para mejorar la penetración de la hoja.

Asiento para el tubo diseñado para una mínima deformación del tubo en el corte.



Presentación / Product display

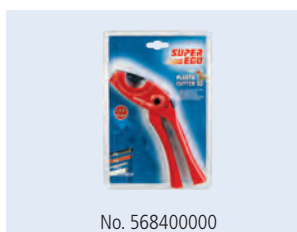

No. 568400000

Plastic pipe shears Ø 32 mm

For precise cutting of plastic pipes: PP, PE, PEX, PVC, PB, PVDF.
Capacity of 1/4" (32 mm.)

Made of primary aluminium for lightness and robustness. Ergonomic design.

Replaceable flat stainless steel blade.

Safety lock.

"TURN & CUT" system for easy blade penetration.

Pipe support for minimum pipe distortion in the cutting operation.

Quick blade return by pressing a button.

DATOS TECNICOS / TECHNICAL DATA

Capacidad / Capacity: **0-32 mm (0 -1.1/4")**
Aplicación / Application: **PP, PE, PEX, PVC, PB, PVDF**

"TURN & CUT"



Made in Spain

No.	in	mm	kg		
568400000	0-1.1/4	0-32	0,2	•	4
568400300	1 ud.		0,1	•	1

Cuchilla / Cutter wheel

Tijera para tubo de plástico Ø 42 mm

Para el corte de tubos de plástico: PP, PE, PEX, PVC, PB, PVDF.
Con capacidad de 1.5/8" (42 mm.)

Fabricadas con aluminio de primera fusión, confiere una gran ligereza y robustez. Diseño ergonómico.

Empuñadura superior con caucho antideslizante.

Cuchilla con avance progresivo sin retorno. En forma de "V" que permite un corte limpio y rápido.

Plastic pipe shears Ø 42 mm

For precise cutting of plastic pipes: PP, PE, PEX, PVC, PB, PVDF.
Capacity of 1/4" (32 mm.)

Made of primary aluminium for lightness and robustness. Ergonomic design.

Upper handle with non-slip rubber.

Non-return progressive feed "V" shaped blade for a clean and quick cut.

DATOS TECNICOS / TECHNICAL DATA

Capacidad / Capacity: **0-42 mm (0 -1.5/8")**
Aplicación / Application: **PP, PE, PEX, PVC, PB, PVDF**



No. 568022400

Made in Spain

No.	in		mm		kg	●	☐
	0-1.5/8		0-42				
568020000					0,4	●	4
S00520000			568020000 x 10 ud.				1
Cuchilla / Cutter wheel							
568022400			1 ud.		0,1	●	1

Presentación / Product display



No. 568020000



No. S00520000

1

Tijera para tubo de plástico Ø 50 mm

Para el corte de tubos de plástico: PP, PE, PEX, PVC, PB, PVDF.
Con capacidad de 2" (50 mm.)

Fabricadas con aluminio de primera fusión, confiere una gran ligereza y robustez. Diseño ergonómico.

Empuñadura superior con caucho antideslizante.

Cuchilla de acero inoxidable intercambiable con avance progresivo sin retorno. En forma de V que permite un corte limpio y rápido.

Cierre de seguridad.

Retorno rápido de la cuchilla pulsando un botón.



Presentación / Product display



No. 568050000

Plastic pipe shears Ø 50 mm

For precise cutting of plastic pipes: PP, PE, PEX, PVC, PB, PVDF.
Capacity of 2" (50 mm.)

Made of primary aluminium for lightness and robustness. Ergonomic design.

Upper handle with non-slip rubber.

Replaceable non-return progressive feed stainless steel V shaped blade for a clean and quick cut.

Safety lock.

Quick blade return by pressing a button.

DATOS TECNICOS / TECHNICAL DATA

Capacidad / Capacity: **0-50 mm (0 -2")**
Aplicación / Application: **PP, PE, PEX, PVC, PB, PVDF**



No. 568052400

Made in Spain

No.	in	mm	kg		
568050000	0-2	0-50	0,6	•	4
Cuchilla / Cutter wheel					
568052400	1 ud.		0,1	•	1

Tijera para tubo de plástico Ø 63 mm

Para el corte de tubos de plástico: PP, PE, PEX, PVC, PB, PVDF.
Con capacidad de 2.1/2" (63 mm.)

Cortes rectos precisos.

Precisión en el corte, sin deformación.

Mínimo esfuerzo en el corte.

Transferencia de presión precisa y alimentación de la tijera guiada.

Apertura automática y controlada de la cuchilla.

Antideslizante gracias al mango de caucho.

Nueva cuchilla mejorada en forma "V".

Reducción de hasta un 20% de esfuerzo en el corte.



Presentación / Product display



No. 568630000

Plastic pipe shears Ø 63 mm

For precise cutting of plastic pipes: PP, PE, PEX, PVC, PB, PVDF.
Capacity of 2.1/2" (63 mm.)

Made of primary aluminium for lightness and robustness. Ergonomic design.

Upper handle with non-slip rubber.

Replaceable non-return progressive feed stainless steel V shaped blade for a clean and quick cut.

Safety lock.

Quick blade return by pressing a button.

DATOS TECNICOS / TECHNICAL DATA

Capacidad / Capacity: **0-63 mm (0 -2.1/2")**
Aplicación / Application: **PP, PE, PEX, PVC, PB, PVDF**



No. 568632400

Made in Spain

No.	in	mm	kg		
568630000	0-2.1/2	0-63	0,7	•	4
Cuchilla / Cutter wheel					
568632400	1 ud.		0,1	•	1

Tijera para tubo de plástico Ø 75 mm

Para el corte de tubos de plástico: PP, PE, PEX, PVC, PB, PVDF.
Con capacidad de 3" (75 mm.)

Fabricada con aluminio de primera fusión, confiere una gran ligereza y robustez. Diseño ergonómico.

Cuchilla con avance progresivo sin retorno. Retorno rápido de la cuchilla abriendo los mangos.

Doble mango antideslizante.

Cierre de seguridad.

Plastic pipe shears Ø 75 mm

For precise cutting of plastic pipes: PP, PE, PEX, PVC, PB, PVDF.
Capacity of 3" (75 mm.)

Made of primary aluminium for lightness and robustness. Ergonomic design.

Non-return progressive feed stainless. Quick blade return by opening the handles.

Double non-slip handle.

Safety lock.

DATOS TECNICOS / TECHNICAL DATA

Capacidad / Capacity: **0-75 mm (0-3")**
Aplicación / Application: **PP, PE, PEX, PVC, PB, PVDF**



Made in Spain

No.	in	mm	kg		
568750000	0-3	0-75	1,6	•	1
Cuchilla / Cutter wheel					
568752400			1 ud.	•	1

Presentación / Product display



1

No. Cortatubos / Tube cutter	in.	mm									
---------------------------------	-----	----	--	--	--	--	--	--	--	--	--



716 / 722 MINI

716000000	1/8-5/8	3-16	Cu	716000500	10	70006	1				
722000000	1/4-7/8	6-22	SS (INOX)	716001500	10						

716 / 722 MINI PRO

716200000	1/8-5/8	3-16	Cu	735000500	5	70041	1				
722200000	1/4-7/8	6-22	MLP	735010500	5						
			SS (INOX)	735001500	5						



MINICUT 72210 / MINIMAX 728

716200000	1/4-7/8	6-22	Cu	735000500	5	70041	1				
728000000	1/8-1.1/8	3-28	MLP	735010500	5						
			SS (INOX)	735001500	5						



Cortatubos 735 / Tube cutter 735

735000000	1/4-1.3/8	6-35	Cu	735000500	5	70041	1	21652	1		
			MLP	735010500	5						
			SS (INOX)	735001500	5			735002300	1		
			PP - PE	763012200	5						



Cortatubos 742 PRO / Tube cutter 742 PRO

742000000	1/4-1.5/8	6-42	Cu	735000500	5						
			MLP	735010500	5						
			SS (INOX)	735001500	5						
			PP - PE	763012200	5						



Cortatubos 725 PRO / Tube cutter 725 PRO

725200000	1/8-1.1/8	3-30	Cu	735000500	5						
			MLP	735010500	5						
			SS (INOX)	735001500	5						
			PP - PE	763012200	5						



Cortatubos 726 PRO / Tube cutter 726 PRO

726000000	1/4-1.5/8	6-42	Cu	735000500	5	70006	1				
			MLP	735010500	5						
			SS (INOX)	735001500	5						











Cortatubos automático 750 / Automatic tube cutter 750

750000000	1/4-2.5/8	6-67	Cu	735000500	5	70042	1			750004100	1
750010000	1/4-2.5/8	6-67	MLP	735010500	5						
			PP - PE	763012200	5						

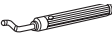

Cortatubos automático 751-752 / Automátic tube cutter 751-752

751020000	2-5	50-127	Cu	737000500	8	751004200	1	751004100	1		
751010000	2-5	50-127	PP - PE 40 mm Ø	737012200	8						
751000000	2-5	50-127	PP - PE 30,5 mm Ø	737032200	8						
751030000	4-6.5/8	100-168	PP - PE 45 mm Ø	738012200	8						

No. Cortatubos / Tube cutter	in.	mm									
---------------------------------	-----	----	---	---	---	---	---	---	---	---	---





Cortatubos para hierro 701 / Steel pipe cutter 701

701010000	1/8-1.1/4	10-31	Fe - Steel	701010500	5	701011500	1				
701020000	1/8-2	10-60	Fe - Steel	710020500	5	70053					



Cortatubos para hierro 710 / Steel pipe cutter 710

710040000	2-4	60-115	Fe - Steel	710040500	3	70064	1				
------------------	-----	--------	------------	-----------	---	-------	---	--	--	--	--

No. Tijera/ Shears	in.	mm			
-----------------------	-----	----	--	--	--



Tijera para tubo de plástico Ø 32 mm

568400000	0-1.1/4	0-32	PP, PE, PEX, PVC, PB, PVDF	568400300	1
------------------	---------	------	----------------------------	-----------	---



Tijera para tubo de plástico Ø 42 mm

568020000	0-1.5/8	0-42	PP, PE, PEX, PVC, PB, PVDF	568022400	1
------------------	---------	------	----------------------------	-----------	---



Tijera para tubo de plástico Ø 50 mm

568050000	0-2	0-50	PP, PE, PEX, PVC, PB, PVDF	568052400	1
------------------	-----	------	----------------------------	-----------	---



Tijera para tubo de plástico Ø 63 mm

568630000	0-2.1/2	0-63	PP, PE, PEX, PVC, PB, PVDF	568632400	1
------------------	---------	------	----------------------------	-----------	---



Tijera para tubo de plástico Ø 75 mm

568750000	0-3	0-75	PP, PE, PEX, PVC, PB, PVDF	568752400	1
------------------	-----	------	----------------------------	-----------	---

Muelle curvatubos 769

Para el curvado libre de tubos de cobre recocido y de aluminio.
Para el curvado de tuberías blandas delgadas, gracias a que el muelle impide el arrugado de las paredes del tubo en los puntos de curvado.

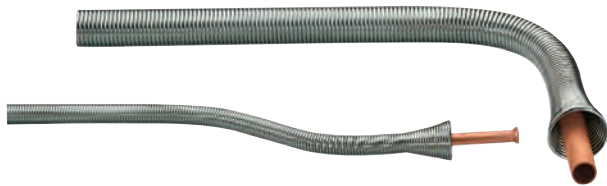

Spring tube spring 769

Free bending of soft copper and aluminium tubins.
Handy tool for bending thin soft pipes, the spring preventing pipe wall wrinkling at bending points.

DATOS TECNICOS / TECHNICAL DATA

Capacidad / Capacity: **180°**
Aplicación / Application: **Cu-Al**

No.	∅	No.	∅	kg		
25181	5/16"	25181	8 mm	0,1	•	1
		25182	10 mm	0,1	•	1
		25183	12 mm	0,1	•	1
25190	1/2"	25185	15 mm	0,2	•	1
21186	5/8"	25186	16 mm	0,2	•	1

Tenaza curvatubos 761

Diseñado para el curvado de tuberías de cobre recocido y aluminio.
Curvado de precisión hasta 180° para diámetro exterior de 6, 8 y 10 mm.
La escala graduada permite curvados parciales (45°, 90° y 135°).
La posición del mango permite curvar de 0° a 180° con una sola operación.



Multisize tube bender 761

Free bending of soft copper and aluminium tubins.
Precision bending up to 180° for 6, 8 and 10 mm O.D.
Graduated scale for specific bends (45°, 90° and 135°).
Handle position allows bending from 0° to 180° in a single operation.

DATOS TECNICOS / TECHNICAL DATA

Capacidad / Capacity: **180°**
Aplicación / Application: **Cu-Al**

Presentación / Product display



No.	∅	kg		
761000000	6 - 8 - 10 mm	0,42	•	1
761020000	1/4" - 5/16" - 3/8"	0,42	•	1

Tenaza curvatubos 760

Diseñada especialmente para el curvado de tuberías de cobre recocido, latón y aluminio así como de tuberías de acero de pared delgada.
Herramienta ligera para un fácil curvado.
Permite curvar de 0° a 180° en todos los planos sin deformar la tubería.



Tube bender 760

Specially designed for bending soft copper, brass and aluminium tube as well as thin wall steel pipes.
Light tool for easy bending.
For bending pipes from 0° to 180° in all planes without tube distortion.

DATOS TECNICOS / TECHNICAL DATA

Capacidad / Capacity: **180°**
Aplicación / Application: **Cu-Al**

Presentación / Product display



No.	∅	No.	∅	kg		
760080000	1/4"	760060000	6 mm	0,5	•	1
		760080000	8 mm	0,5	•	1
		760100000	10 mm	0,8	•	1
760160000	1/2"	760120000	12 mm	0,9	•	1
		760140000	14 mm	1,6	•	1
		760150000	15 mm	1,7	•	1
760180000	5/8"	760160000	16 mm	1,7	•	1
		760180000	18 mm	1,9	•	1

Tenaza curvatubos 765

Para el curvado hasta 180° tubos de cobre recocido, acero y aluminio.

Fabricado en aluminio monoblock.
Capacidad: 10 - 18 mm Ø.

DATOS TECNICOS / TECHNICAL DATA

Capacidad / Capacity: **180°**
Aplicación / Application: **Cu-Al, SS (Inox)**



Puede ser utilizado en un banco de trabajo.
Can be attached to a work bench.

Made in Spain

No.	Ø	kg		
765100000	10 mm	0,35	•	1
765120000	12 mm	0,60	•	1
765140000	14 mm	0,95	•	1
765160000	16 mm	1,70	•	1
765180000	18 mm	2,10	•	1

Tube bender 765

For bending soft copper, steel and aluminium pipes up to 180°.

Made of monoblock aluminium.
Capacity 10 - 18 mm Ø.

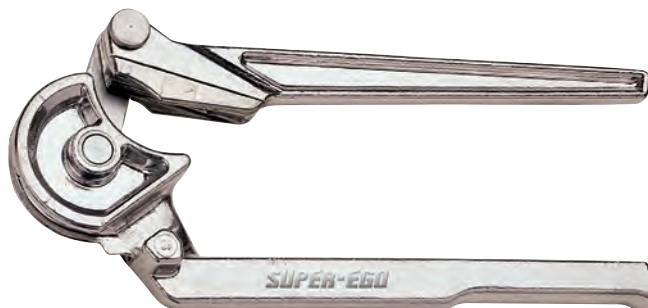

Tenaza curvatubos PRO

Curvatubos de cobre semiduro y duro.

Curvatubos INOX espesor de 0,8 - 1 mm.
Cuerpo de hierro fundido para una prolongada vida.
Galleta de aluminio que asegura un curvado correcto.
Patín de poliamida reforzada con fibra de vidrio.
Empuñadura de goma para una uso comodo.

DATOS TECNICOS / TECHNICAL DATA

Capacidad / Capacity: **180°**
Aplicación / Application: **Cu, SS (Inox)**



Puede ser utilizado en un banco de trabajo.
Can be attached to a work bench.

Made in Spain

No.	Ø	kg		
767050000	1/2"	2,2	•	1
767750000	3/4"	2,25	•	1

Tube bender PRO

Tube bender for rigid and semi rigid copper.

Stainless Steel up to 1 mm wall thickness.
Cast iron body for extended life.
Aluminium former for proper bends.
Glass reinforced polyamide shoe.
Rubber grip for easy operation.



Presentación / Product display



No. 767050000

Curvadora hidráulica manual 3/8"- 2"

Para el curvado en frío de tubos de acero y galvanizados de 3/8" a 2". Curvado de 0° a 90°.

Armazón de curvado con placa doble y radio largo que proporciona un máximo rendimiento y seguridad.

Apertura automática del mango.

Sistema hidráulico cerrado que requiere poco mantenimiento.

Diseño monoblock con retorno de pistón automático.

Reduce las uniones soldadas.

Reducidas dimensiones y de construcción sólida, compacta y resistente.

Manual hydraulic bender 3/8"- 2"

Cold bending of carbon steel and galvanised steel pipes up to 3/8"-2". From 0° to 90°.

Double plate long radius bending frame to provide maximum efficiency and safety.

Handle automatic opening.

Closed hydraulic system for low maintenance needs.

Manual monoblock equipment, with automatic release.

Reduces welded connections.

Reduced dimensions, compact solid construction, versatile and portable bender.

Retorno automático del pistón, una vez cargado.

Automatic piston return, once loaded.

Palanca de accionamiento manual.

Manual operating lever.

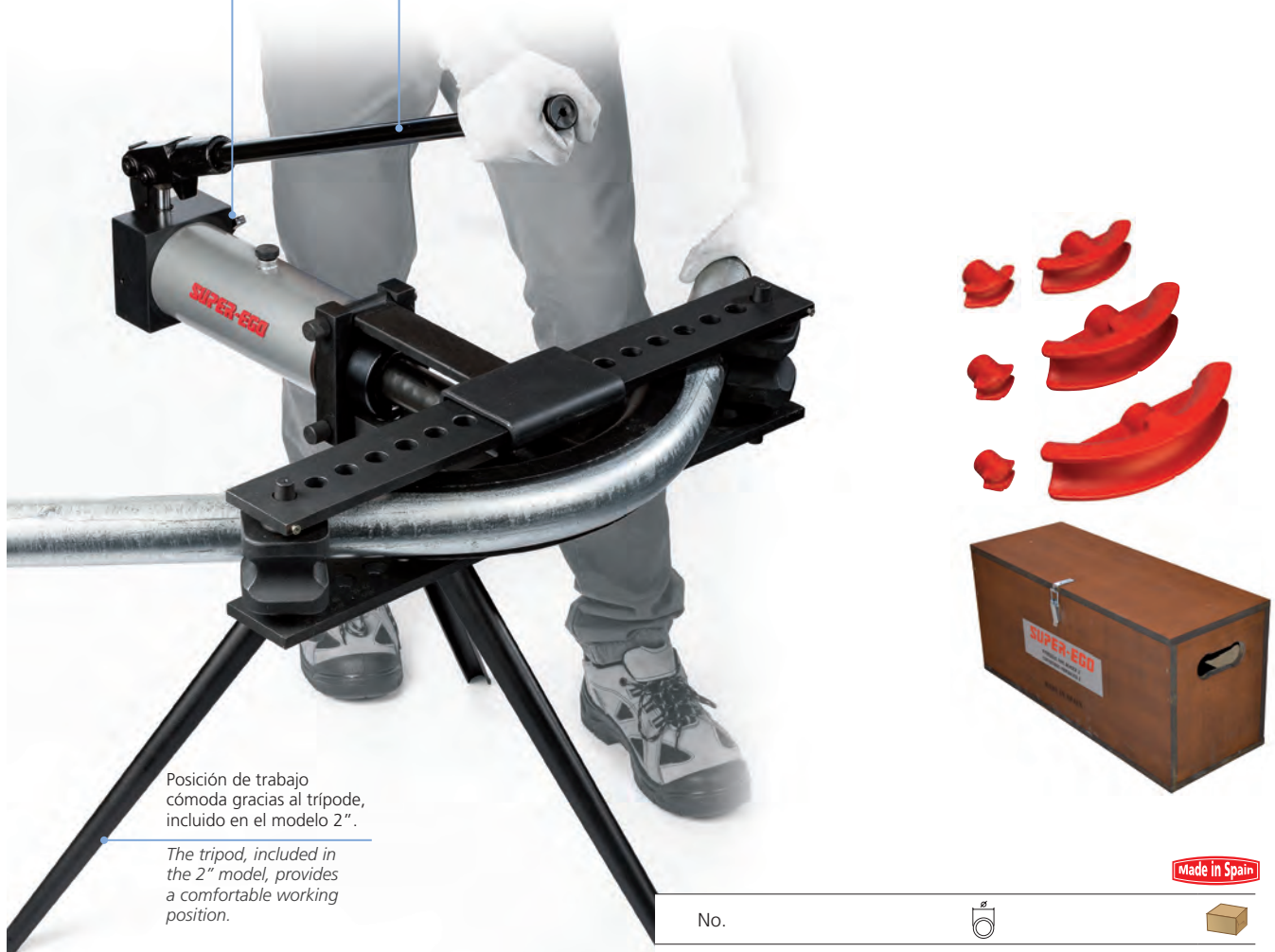

Posición de trabajo cómoda gracias al trípode, incluido en el modelo 2".

The tripod, included in the 2" model, provides a comfortable working position.



Se suministra en una caja de madera reforzada para almacenamiento y transporte que incluye: equipo hidráulico, juego de hormas en radio corto, placa doble y diábolos..

Delivered in a wooden case for storage and transport, includes: hydraulic bender, short radius formers set, double plate and pivot pipe supports.

No.	kg	
100000757	67	1

DATOS TECNICOS / TECHNICAL DATA

Curvado / Bender:	0° - 90°
Capacidad / Capacity:	3/8"-2"
Aplicación / Application:	Steel
Max. potencia / Max. force:	15 Tn.

No.		
Hormas radio corto / Short radius formers		
57985	3/8"	1
57986	1/2"	1
57987	3/4"	1
57988	1"	1
57989	1.1/4"	1
57990	1.1/4"	1
57991	2"	1
Diábolos / Pivot pipe supports		
772201200		1
772201100		1
Trípode / Tripod		
57352		1

Made in Spain

Curvadora hidráulica manual 772-773

Curva en frío tubos de acero negro y galvanizados de hasta 2" y 3" entre 0° y 90°.

Válvula de seguridad para evitar daños en caso de sobrecarga.
Sistema hidráulico cerrado que requiere poco mantenimiento
Diseño monoblock con retroceso automático
Reducidas dimensiones y de construcción sólida, compacta y resistente.

Manual hydraulic bender 772-773

Cold bending of carbon steel and galvanised steel pipes up to 2" and 3" from 0° to 90°.

Safety valve to prevent damage in case of overload.
Closed hydraulic system for low maintenance needs.
Manual monoblock equipment, with automatic release.
Reduced dimensions, compact solid construction, versatile and portable bender.

DATOS TECNICOS / TECHNICAL DATA

Curvado / Bender: **0-90°**
Capacidad / Capacity: **2"-3"**
Aplicación / Application: **Steel**
Max. potencia / Max. force: **15 Tn.**



Se suministra en una caja de madera reforzada para almacenamiento y transporte que incluye: equipo hidráulico, juego de hormas en radio corto o largo, placa doble o única y diábolos.
Delivered in a wooden case for storage and transport, includes: hydraulic bender, short or long radius formers set, simple or double plate and pivot pipe supports.

No.		Norma/ Norm	Radio/ Radius	kg	
2" Placa simple / Single plate					
1000001833	3/8-1/2-1-3/4-1.1/4-1.1/2-2	DIN-2440-41	Corto/Short	63,1	1
1000001835	3/8-1/2-1-3/4-1.1/4-1.1/2-2	DIN-2440-L	Largo/Long	69,6	1
2" Placa doble / Double plate					
1000001832	3/8-1/2-1-3/4-1.1/4-1.1/2-2	DIN-2440-41	Corto/Short	61,3	1
1000001834	3/8-1/2-1-3/4-1.1/4-1.1/2-2	DIN-2440-L	Largo/Long	67,7	1
3" Placa doble (trípode no incluido) / Double plate (tripod not included)					
1500002308	1/2-1-3/4-1.1/4-1.1/2-2-3	DIN-2440-41	Largo/Long	120,0	1

No.		
Hormas radio corto / Short radius formers		
57985	3/8"	1
57986	1/2"	1
57987	3/4"	1
57988	1"	1
57989	1.1/4"	1
57990	1.1/2"	1
57991	2"	1
Diábolos / Pivot pipe supports		
772201200		1
772201100		1
Trípode / Tripod		
57352		1

ROBEND® 4000

Válida para doblar todos los diámetros cambiando la posición del eje del patín y las matrices.

Cambio de marcha mecánico. Dispositivo de caja reductora para la palanca de mecánica. Cambio de sentido de marcha por medio del reductor. Paro inmediato de la máquina al conseguirse el ángulo establecido.

Motor con doble aislamiento de acuerdo VDE/CEE. Escobillas de grafito de bloqueo automático con fácil acceso para sustitución.

Interruptor de seguridad antibloqueo.

ROBEND® 4000

Valid for bending all diameters by changing the position of the shoe shaft and formers.

Mechanical speed change. Gear box lever for mechanical speed change. Reversal of direction of rotation through the gear box. Instant stop on reaching the desired angle.

Universal electric motor with double insulation according to VDE/CEE. Self-locking graphite brushes with easy access for replacement. Safety switch with locking protection.

DATOS TECNICOS / TECHNICAL DATA

Capacidad / Capacity:	0° - 180°
Corriente / Current:	230V - 110V
Motor / Motor:	1.010 W 50/60 Hz

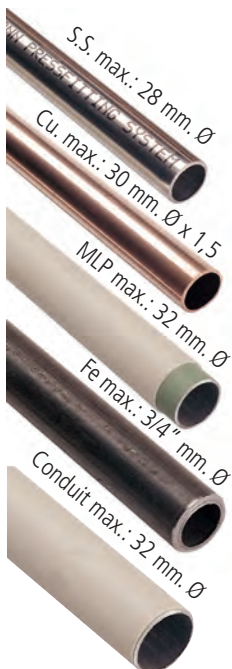

El ángulo de curvado se ajusta manualmente para ángulos de 0° a 180°.

Manual adjustment of the bending angle from 0° to 180°.



Utilizando el trípode opcional, ROBEND® 4000 puede trabajar a una altura idónea evitando así la suciedad y aceites del suelo.

Using the optional trisland, ROBEND® 4000 can work at suitable height to avoid floor dirt and oils.

Gran reducción de la transmisión merced a su tren de engranajes con siete ejes paralelos montados sobre rodamientos de bolas, que permiten una transmisión constante del nivel de potencia.

Reduce de 32.000 a 3 r.p.m. gracias a su cadena cinemática de diseño especial, que asegura un suave rendimiento del motor.

Lubricación constante de todos los elementos internos.

High transmission reduction through seven parallel, ball bearing mounted gear shafts, providing constant level power transmission.

Reduction from 32.000 to 3 r.p.m. is achieved through a specially designed kinematic chain ensuring a smooth motor performance.



Constant lubrication of all the internal elements.

Set en estuche de plástico resistente que incluye una curvadora eléctrica ROBEND® 4000, matrices de curvar y patines para varios diámetros de tuberías y eje de patín.



Complete sets in robust plastic carrying case including one portable power pipe bender ROBEND® 4000, bending formers and shoes for various pipe sizes and shoe shaft.



No.				kg	
1200001367	ROBEND® 4000	230V	12,9	1	
1200001366	ROBEND® 4000	110V	12,9	1	
1000001532	12, 15, 18, 22, 28 mm	230V	26,6	1	
1000001534	15, 18, 22, 28 mm	230V	26,4	1	
1000001533	18, 22, 28 mm	230V	25,9	1	
1000001543	1/2-3/4-1"	110V	24,0	1	
1000001538	1/2-5/8-3/4-7/8-1"	230V	24,0	1	
1000001537	20, 25, 32 mm	230V	23,0	1	
1000001536	16, 20, 25, 32 mm	230V	24,0	1	
1000001535	15, 18, 22 mm	230V	23,9	1	
1000001540	12, 14, 16, 18, 22, 28 mm + Trípode/ Tripod	230V	28,3	1	

Accesorios / Accessories

995808400	Estuche / Carrying case		3,4	1
25748	Trípode/ Tripod		3,4	1
25743	Conjunto eje fijación / Guide shoe axle		0,4	1



Set de hormas

Hormas de aluminio ligeras, de larga duración y altamente resistentes. Patín de baja fricción patentado, fabricado en poliamida de alta calidad para evitar roturas. Con dos puntos para lubricación.



Hormas de aluminio.
Aluminium formers.

Patines.
Shoes.

No.	 Nominal size	Radio Bend radius	kg	
O.D. mm (Cu-Al, SS (Inox))				
25612	12 mm	42 mm	0,4	1
25614	14 mm	49 mm	0,6	1
25615	15 mm	52,5 mm	0,5	1
25616	16 mm	56 mm	0,6	1
25618	18 mm	72 mm	1,1	1
25620	20 mm	80 mm	1,3	1
25622	22 mm	88 mm	1,4	1
25628	28 mm	112 mm	2,9	1
Conduit				
25616	16 mm	56 mm	0,6	1
25620	20 mm	80 mm	1,3	1
25625	25 mm	112 mm	2,9	1
25666	32 mm	103 mm	2,9	1





Set of formers

Light aluminium formers, long lasting and extremely strong. Patented low friction shoe, made of high quality polyamide to prevent flaws. With two lubrication points.



Compuesto de hormas de aluminio forjado y el patín de curvado correspondiente.

Comprising forged aluminium formers and the applicable bending hoe.

No.	 Nominal size	Radio Bend radius	kg	
O.D. inches " (Cu-Al, SS (Inox))				
25652	1/2"	45	0,6	1
762955300	5/8"	56	0,6	1
25619	3/4"	80	1,3	1
762955700	7/8"	88	1,4	1
25625	1"	112	2,9	1
25626	1.1/8"	112	2,9	1
Nominal D inches " (Acero / Steel pipe)				
762965100	(2440-41) 1/4"	55	0,5	1
762965200	(2440-41) 3/8"	80	1,3	1
25684	(2440-41) 1/2"	88	1,4	1
25685	(2440-41) 3/4"	112	2,9	1
D. E. mm (MPS-H)				
25820	20	88	1,4	1
25830	30	112	2,9	1
4R (Cu, MLP)				
1000001561	1.1/4" - 32 mm			1
1000001563	1.3/8" - 35 mm			1

1

Set de abocinado y expandido 490

Para tubos de cobre recocido, aluminio y latón.

Se suministran dos reglas para abocinar 9 tamaños. 1/8", 3/16", 1/4", 5/16", 3/8", 7/16", 1/2", 5/8" y 3/4".

Alimentación por tornillo, ideal para trabajos en espacios reducidos.

5 adaptadores para expandir tubos de 3/16", 1/4", 5/16", 3/8", 1/2", 5/8" y 3/4".

Horquilla libre de centrado automático, de acero forjado.



Set of flaring tool and swaging 490

For soft copper, aluminium and brass tubes.

Two rulers are provided to flare 9 sizes. 1/8", 3/16", 1/4", 5/16", 3/8", 7/16", 1/2", 5/8" and 3/4".

Screw fed, ideal to work in confined spaces.

5 adapters for expanding 3/16", 1/4", 5/16", 3/8", 1/2", 5/8" and 3/4" tubes.



Automatic forged steel centring yoke.

DATOS TECNICOS / TECHNICAL DATA

Aplicación / Application: **Cu, Al, Brass (latón)**



Made in Spain

No.	Cortatubos Pipe cutter			kg	
490000000		1/8" - 3/4"	3/16" - 3/4"		1
490030000	722100000	1/8" - 3/4"	3/16" - 3/4"	2,3	1
Regla / Ruler 21062			10 - 22 mm		1

Abocinadores 491-492

Para tubos de cobre recocido, aluminio y latón.

Horquilla de acero forjado y reglas galvanizadas.

Centrado automático.

La regla expansora evita el deslizamiento del tubo.

El cono templado proporciona abocardados S.A.E. a 45°.

4 conjuntos en estuche de plástico que incluye: cortatubos 725, expandidor 491 o 492. Con posibilidad bajo pedido de suministrarlo con inserciones para doble abocardado.



Flaring tools 491-492

For soft copper, aluminium and brass tubes.

Forged steel yokes and galvanised pipe clamp.

Automatic centring yoke.

The cold rolled pipe clamp prevents the tube from slipping.

The hardened cone provide 45° S.A.E. flares.



4 sets in carrying case including: pipe cutter 725, flaring tool 491 or 492. Double flaring inserts available on order.

DATOS TECNICOS / TECHNICAL DATA

Aplicación / Application: **Cu, Al, Brass (latón)**



491030000

No.	Cortatubos Pipe cutter		kg	
491000000		3/16" - 5/8"	0,9	1
491030000	725000000	3/16" - 5/8" (doble abocinado/double flaring)	1,30	1
491050000	725000000	3/16" - 5/8"	1,26	1
492000000		4-14 mm	0,9	1
492030000	725000000	4-14 mm (doble abocinado/double flaring)	1,30	1
492050000	725000000	4-14 mm	1,26	1

Abocinadores 493

Para tubos de cobre recocido, aluminio y latón.

Abocardados lisos y uniformes con el mínimo esfuerzo, aún en tamaños grandes. La gran manilla de avance de rosca de cómodo agarre gira fácilmente.

El cono de acero inoxidable produce un abocardado de espesor uniforme. Se afloja fácilmente al final de la expansión.

El diámetro de los tubos está claramente marcado.

Horquilla con patilla de agarre para el apriete con tornillo de banco.

DATOS TECNICOS / TECHNICAL DATA

Aplicación / Application: **Cu, Al, Brass (latón)**

Flaring tools 493

For soft copper, aluminium and brass tubes.



Smooth and uniform flares with minimum effort, even in large sizes. Stainless steel cone for flares with even thickness. Easy release at the end of the expansion.

Clearly marked pipe sizes.

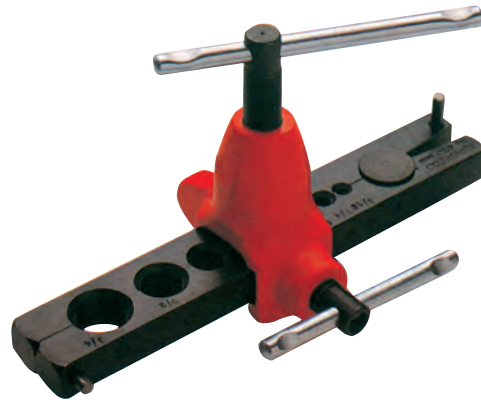
The yoke is provided with a flange for bench vice grip.



Made in Spain

No.		kg	
493000000	3/16"-3/4"	1,25	1

Abocinador universal

Para abocinado de tubos de 1/4", 5/16", 3/8", 1/2", 5/8", 3/4".

Con anillado y remachado que garantiza un uso prolongado y una buena fiabilidad.

La empuñadura de diseño ergonómico garantiza una carga de trabajo confortable y eficiente.

La excentricidad del cono garantiza un uso prolongado de los tubos de cobre sin fracturas.

Universal Flaring Tool

For flaring tubes of de 1/4", 5/16", 3/8", 1/2", 5/8", 3/4".

Flaring bar with annular riveted process ensures prolong usage and reliability.

The arc transition designs of the horn aperture guarantees copper pipe prolong usage without fracturing it.

The eccentricity of the cone ensures a prolonged use of copper pipes without fracturing

DATOS TECNICOS / TECHNICAL DATA

Aplicación / Application: **Cu, Al, Brass (latón)**



No.		kg	
1500001408	Abocinador / Flaring tool	1,25	1

Abocinador excéntrico

Abocinador especialmente diseñado para abocardados lisos.

Realizar abocardados uniformes con el mínimo esfuerzo.

Cono abocinador de acero templado, montado excéntricamente en cojinete de agujas generando paredes abocinadas uniformes.

Sistema de autobloqueo de bola, fija fácilmente las barras de abocinar.

Posibilidad de ser suministrado en mm o pulgadas.



Eccentric flaring tool

Flaring tool designed specially for smooth flares.

Performs uniform flares with minimum effort.

Flare cone made of hardened steel eccentrically mounted on needle bearing to produce uniform flare walls.

The flaring tool has an auto-lock ball system for easy centring the flare bars.

Available in mm.

DATOS TECNICOS / TECHNICAL DATA

Aplicación / Application: **Cu, Al, Brass (latón)**

No.		kg	
R22240200	1/8"-3/4"	0,70	1

Abocinador para plomo

El cono dentado evita el deslizamiento del tubo.

Indispensable para las instalaciones de tubo de plomo.



Lead flaring tool

The toothed cone avoids pipe slip.

Essential for lead pipe installations.

No.	
480010000	1

Tenaza de sifón

Adecuada para uso de accesorios roscados de PVC y piezas de superficie delicada.

Fabricada en acero.

Cuatro posiciones de apertura.

Las mordazas de plástico agarran las piezas sin dañarlas.



Sanigrip pliers

Ideal for threaded PVC accessories and sensitive surfaces.

Made of steel.

Four opening positions.

Plastic jaws prevent gripping damage.

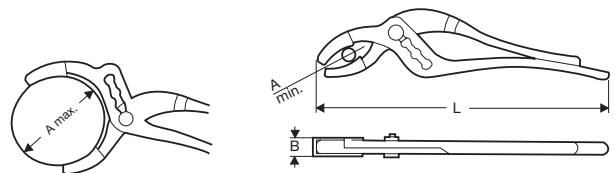

No.	L		A max		B	kg		
	in	mm	in	mm	mm			
530100000	10	250	62	14	14	0,2	•	4
Sin bocas de plástico / Without plastic jaws								
530102000	10	250	62	14	14	0,2	•	4

Bomba de comprobación TP120

Para realizar comprobaciones de precisión de tuberías de agua y contenedores de hasta 120 bar.

El sistema de válvula de doble función única permite el ajuste fino y preciso de la presión y la autocomprobación de la bomba.

Pistón de latón para una menor fricción y una mayor duración, su diámetro permite conseguir 120 bar con un menor esfuerzo.

Nuevo sistema de palanca más ergonómico que reduce el esfuerzo para obtener 120 bar.

Tanque galvanizado resistente a todo tipo de inclemencias meteorológicas.

DATOS TECNICOS / TECHNICAL DATA

Presión / pressure:	0 - 120 bar
Depósito / tank:	10,5 l
Conexión / connection:	R1/2"
Peso / Weight:	7 Kg.
Dimensiones / Dimensions:	490 x 160 x 250 mm.
Flujo / Water flow rate:	66 ml por bombeo/per stroke

Made in Spain

No.			
			
1000001903	TP120		1
Kit de mantenimiento / Maintenance kit			
1000002163			1

Testing pump TP120

For precision testing of water lines and containers up to 120 bar.

Unique dual function valve enables self testing of the pump as well as precise fine adjustment of the pressure.

Brass piston for lower friction and longer life, its diameter allows reaching 120 bar with less physical effort.

New and more ergonomic lever system to reduce the effort to reach 120 bar.

Weather proof galvanized tank.



Bomba de comprobación RP50-S

Para realizar comprobaciones de precisión de tuberías de agua y contenedores de hasta 60 bar.

El sistema TWIN-VALVE junto con el vástago anti-corrosión aseguran niveles de presión constantes.

Pistón de poliamida rígido y resistente.

Manómetro fácil de leer y preciso.

Depósito galvanizado resistente a las inclemencias meteorológicas.

Cuerpo de válvula monoblock.

DATOS TECNICOS / TECHNICAL DATA

Presión / pressure:	60 bar
Depósito / tank:	12 l.
Conexión / connection:	R1/2"
Peso / Weight:	8 Kg.
Dimensiones / Dimensions:	720 x 170 x 260 mm.
Flujo / Water flow rate:	45 ml por bombeo/per stroke

Made in Spain

			
No. 1000000591			
R6020000	RP50-S		1
Kit de mantenimiento / Maintenance kit			
1000000591			1

Testing pump RP50-S

For precision testing of water lines and containers up to 60 bar.

The TWIN-VALVE system and rust-proof ball head valve spindle ensure constant pressure levels.

Rigid polyamide piston, wear resistant.

Easy reading and accurate scale pressure gauge.

Weather proof low temperature resistant galvanised painted tank.

Monoblock valve body.



Bomba de comprobación TP40-S

Para realizar comprobaciones de precisión de tuberías de agua y contenedores de hasta 60 bar.

El sistema TWIN-VALVE junto con el vástago anti-corrosión aseguran niveles de presión constantes.

Doble válvula de bola para un más fácil mantenimiento.

Fácil lectura de presión gracias a su preciso manómetro integrado en el cuerpo.



Testing pump TP40-S

For precision testing of water lines and containers up to 60 bar.

The TWIN-VALVE system and rust-proof ball head valve spindle ensure constant pressure levels.

Double ball valves for easy maintenance.

Easy reading and accurate scale pressure gauge integrated in operating panel.

DATOS TECNICOS / TECHNICAL DATA

Presión / pressure:	60 bar
Depósito / tank:	6,5 l.
Conexión / connection:	R1/2"
Peso / Weight:	5,5 Kg.
Dimensiones / Dimensions:	700 x 190 x 250 mm.
Flujo / Water flow rate:	45 ml por bombeo/per stroke



No. 1000000592

Made in Spain

No.



R6022000	TP40-S	1
Kit de mantenimiento / Maintenance kit		
1000000592		1

Bomba de comprobación TP25

Para realizar comprobaciones de precisión de tuberías de agua y contenedores de hasta 25 bar.

El sistema TWIN-VALVE junto con el vástago anti-corrosión aseguran niveles de presión constantes.

Pequeña, ligera y portátil.

Tanque galvanizado resistente a todo tipo de inclemencias meteorológicas.

Ahora con válvula de purga mejorada.



Testing pump TP25

For precision testing of water lines and containers up to 25 bar.

The TWIN-VALVE system and rust-proof ball head valve spindle ensure constant pressure levels.

Small, light and portable.

Weather proof low temperature resistant galvanised painted tank.

Now with improved bleed valve.

DATOS TECNICOS / TECHNICAL DATA

Presión / pressure:	25 bar
Depósito / tank:	7 l.
Conexión / connection:	R1/2"
Peso / Weight:	4,6 Kg.
Dimensiones / Dimensions:	380 x 215 x 156 mm.
Flujo / Water flow rate:	16 ml por bombeo/per stroke



No. 1000000590

Made in Spain

No.



V15000000	TP25	1
Kit de mantenimiento / Maintenance kit		
1000000590		1

Bomba de comprobación eléctrica autoaspirante RP-PRO III

Bomba de comprobación eléctrica con autocebado y llenado eléctrico de hasta 40 bar.

Para la realización de pruebas de presión automática en tuberías y contenedores de hasta 40 bar.

Cómodo llenado automático y comprobación de la presión de tuberías y contenedores.

La manguera de comprobación con malla de acero evita los errores de lectura, que pueden producirse cuando la manguera se expande durante el funcionamiento.

El manómetro amortiguado con glicerina absorbe los golpes de presión, lo que facilita la lectura.

Testing pump electric self-priming RP-PRO III

Electric self-priming testing pump up to 40 bar.

For automatic pressure test of pipes and containers up to 40 bar.

Easy automatic filling for pressure checking of pipes and containers.

Testing hose with steel mesh prevents reading mistakes, that can happen due to the expansion of the hose during operation.

Glycerine cushioned pressure gauge absorbs pressure surges for easier pressure reading.

DATOS TECNICOS / TECHNICAL DATA

Presión / pressure:	0-40 bar; 0-570 psi; 0-4 Mpa.
Depósito / tank:	6,5 l.
Voltaje / voltage:	1300 W; 230V 50/60 Hz. 5A
Conexión / connection:	R1/2"
Flujo / Water flow rate:	6 l/min
Peso / Weight:	17,5 Kg.
Altura maxs / Self priming high:	1 m.

Carcasa en ABS. Con asa para un cómodo transporte.

ABS body. With handle for easy carrying.

Válvula para el ajuste de la presión.

Pressure control valve.

Compartimento para guardar el cable eléctrico.

Housing for the power cable.

Manguera de alta presión. L.: 1,2 m. Conexión: R1/2".

High pressure hose. L.: 1.2 m. Connection: R1/2".

Manómetro de glicerina certificado. De fácil lectura, dispone de 3 escalas (bar, psi y Mpa), integrado en la carcasa. Precisión: clase 1.6 (0,96 bar).

Certified glycerine pressure gauge. Easy reading and provided with 3 scales (bar, psi and Mpa), integrated in the body. Accuracy: class 1.6 (0.96 bar).



Manguera de agua. L.: 1,2 m. Con accesorio para conexión rápida al grifo.

Water hose. L.: 1.2 m. With tap quick connect.



No. 1000001069

Made in Spain

No.			
V12100000	RP-PRO III	230V	1
100000593	RP-PRO III	230V. SASO	1
Manguera de alta presión / High pressure hose.			
R6112500	L: 1,2 m. R1/2"		1
Kit de mantenimiento / Maintenance kit			
1000001069			1

Rejilla frontal para la ventilación del motor.

Front grid for motor cooling.

Conexión en el lateral para la manguera de agua.

Water hose side connection.

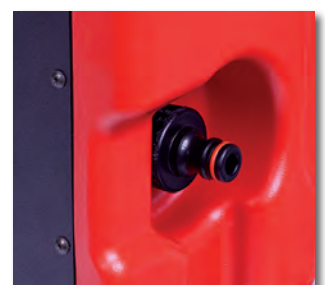

1

Desatascador de ventosa

La solución más económica y conocida para el desatasco en fregaderos, baños, etc.

Gran poder de succión.

Se vende en expositor de 11 unidades.



Sink drain plunger unblocker

The most cost effective solution to unblock sinks, bathtubs, etc.

High suction power.

Sold in displays 11pc.

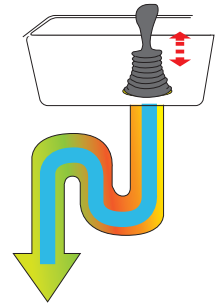

No.



SEH0224

11

Muelle desatascador

Muy útil para desatascar obstrucciones en lavabos, baños, fregaderos, etc...

Diámetro del muelle 7 mm Ø.

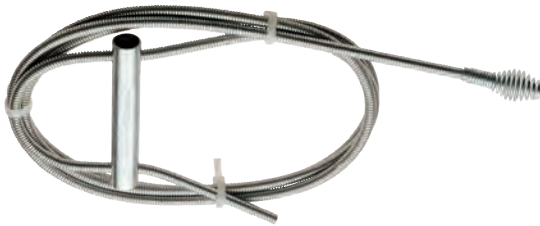

Coil-type cleanout auger

Very useful for cleaning wash basin, bath tub and sink, etc... drains

Spring diameter 7 mm Ø.

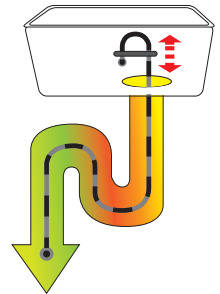

No.



670020000
670050000

2 m 7 mm Ø
5 m 7 mm Ø

10

10

Bomba de desatasco por agua

Especialmente diseñada para eliminar atascos en lavabos, duchas, bañeras, inodoros y sumideros.

La bomba de desatasco por agua une las ventajas de una pistola de agua a presión y de un destascador de aire.



Pump drain unblocker

Specially designed to unblock wash basins, showers, bath tubs, toilet bowls and drains.

The pump drain unblocker combines the benefits of a water pressure gun and air unblocker.



No.



SEH0079

1

Desatascadora doméstica

Indicada para eliminar pequeños atascos en lavabos, fregaderos, bidés, etc. Fácil manejo. Con asa adicional que se puede mover para facilitar el desatasco.

Incluye adaptadores específicos para desatascar inodoros, lavabos y duchas.

DATOS TECNICOS / TECHNICAL DATA

Capacidad / Capacity: **3 l.**

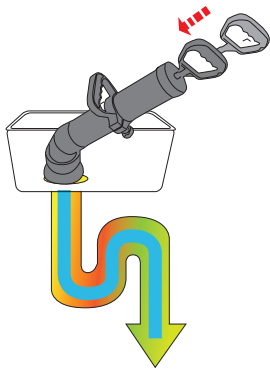

No.



SEH000200

6

Force pump cleaner for home use

Recommended for unblocking small obstructions in wash basins, kitchen sinks, bidets, etc.

Easy to use. Additional handle to facilitate unblocking.

Supplied with specific adaptors for toilets, basins and showers.



Presentación / Product display



Desatascador por golpe de aire

Bomba de aire comprimido.

Manómetro integrado para un desatasco seguro.

Incluye adaptador y tubo flexible para desatascos en lugares de difícil acceso.

DATOS TECNICOS / TECHNICAL DATA

Aplicación / Application: **20 - 100 mm. Ø**

Presión / pressure: **max. 7 bar.**

Peso / weight : **2,9 Kg.**

Dimensiones / Dimensions: **110 mm Ø x 550 mm.**



No.



150000485

1

Pressure drain cleaner

Pressure air pump.

Built-in pressure gauge for safe clearing.

Includes adapter and flexible pipe to clear clogs in hard to reach places.



Desatascador

Accionamiento manual.

Tambor de cable resistente a impactos.

Bloqueo tipo serpiente, con cable flexible y barrena integrada.

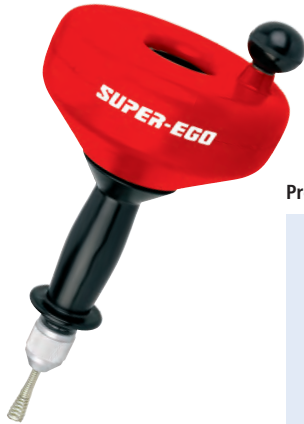

Presentación / Product display



Drain cleaner

Manual unit.

Impact resistant cable container.

Snake locking device, with flexible cable and integrated bulb auger.

DATOS TECNICOS / TECHNICAL DATA

Aplicación / Application: 20 - 75 mm. Ø
Espiral / coil: 6 mm. Ø L: 6 m.

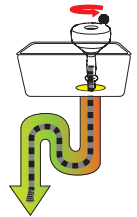

No.



SEH004800

6

Desatascador de tambor manual/taladro

Desatascador de tambor para trabajar con taladro o manualmente.

Tambor metálico.

Ligero, resistente, cómodo y flexible en su funcionamiento.

Espiral flexible con barrena integrada.



Hand/drill operated drain clearing drum

Drain clearing drum for hand or drill operation.

Metallic drum.

Light, resistant, easy and flexible operation.

Flexible coil with built-in auger.

DATOS TECNICOS / TECHNICAL DATA

Aplicación / Application: 20 - 75 mm. Ø
Velocidad / speed: 400 r.p.m.
Espiral / coil: 8 mm. Ø L: 7,6 m.

No.



150000484

1

Varillas desatascadoras

10 varillas flexibles de polipropileno de 1 metro con racores macho-hembra de aleación de zinc con rosca en los extremos, gancho espiral metálico de 2" y disco de goma de 4". En práctica bolsa de malla con asas para el transporte.



Plastic drain cleaning rods

10 flexible polypropylene rods 1 m long with male-female zinc alloy end threaded connectors, 2" metallic worm screw and 4" rubber plunger.

In handy net bag with handles for carrying.

DATOS TECNICOS / TECHNICAL DATA

Aplicación / Application: 50 mm. Ø
Varilla / rod: L: 1 m.

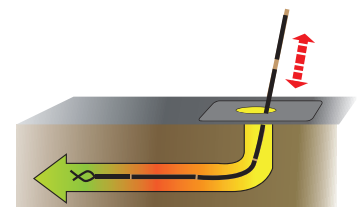

No.



SEH005000

6

POWER-CLEANER

Desatascador instantáneo, que desatasca todo tipo de tuberías sin necesidad de utilizar ácidos o álcalis (sosa caústica), hasta 20 m. de longitud.

No daña las instalaciones. Seguro y fácil de usar.

POWER-CLEANER

Fast unblocking for all type of pipes, no need to use with acids or alkalis (caustic soda) up to 20 m. long.

Does not harm the installation. Safe and easy to use.



Adaptador opcional para inodoros y bañeras.
An adaptor is optional to be used in toilets and baths.

No.		
851500100	POWER-CLEANER	1
8515T0116	POWER-CLEANER + Adaptador / adaptor	1
851509116	Adaptador / adaptor	1

BIOCLEANER

Producto destinado para uso domestico.

Inicia su acción de "digestión" limpiando los desagües, tuberías, fosas, etc... y eliminando completamente la causa de los malos olores.

La limpieza regular de desagües y tuberías, reduce el riesgo de atasco.

Con gran contenido enzimático, a base de enzimas NO patógenas.

Tapón de seguridad.

Acción de biodegradación en 8 horas.

BIOCLEANER

Product for domestic use.

For waste pipes, pipes, septic tanks, etc, completely eliminating the cause for bad smell.

Regular cleaning of waste pipes and pipes drastically reduces the risk of blockage

Big enzymatic content, with NON pathogenic enzymes.

Safety plug.

Biodegradation in 8 hours.



No.		
SEH022800	500 ml.	12

DOMESTIC CLEANER

Producto destinado para uso domestico.

Desatascador - higienizante en Gel SIN ácido sulfúrico.

Resuelve eficazmente y rápidamente los problemas de atasco, actúa en profundidad y con presencia de agua en el desagüe.

DOMESTIC CLEANER

Product for domestic use.

Drain cleaner gel WITHOUT sulphuric acid.

Quickly and efficiently removes blockages, works in depth with water in the waste pipe.



No.		
SEH022700	500 ml.	12

PROFESSIONAL CLEANER

Producto destinado para exclusivo uso profesional.

Desatascador al ácido rápido.

Resuelve eficazmente y rápidamente los problemas de atasco, actúa en profundidad y con presencia de agua en el desagüe.

PROFESSIONAL CLEANER

Product for professional use only.

Rapid acid drain cleaner.

Quickly and efficiently removes blockages, works in depth with water in the waste pipe.



No.		
SEH022600	750 ml.	12

Desatascadora por agua a presión

Equipo profesional de alto rendimiento para el desatasco de alta presión de tubos de Ø 40 a 150 mm.

Para la limpieza de tuberías, sumideros, bajantes de agua de lluvia y canalizaciones.

Elevada potencia que proporciona agua a presión de 100 bar con un flujo de 13 l/m. para una limpieza efectiva.

Equipo con componentes de calidad que garantizan una mayor duración. Posibilidad de diferentes accesorios para una mayor versatilidad de uso.

High Pressure drain cleaning machine

Professional high performance equipment for high pressure unblocking of pipes Ø 40 to 150 mm.

For cleaning pipes, drains, rainwater downpipes and pipelines.

High power to provide pressure water at 100 bar and a flow rate of 13 l/m for effective cleaning.

Quality components for longer useful life.

Availability of different fittings for better versatility of use. Rubber coated handle for better grip.

DATOS TECNICOS / TECHNICAL DATA

Aplicación / Application:	40 - 150 mm. Ø
Longitud / length:	20 m.
Voltaje / voltage:	230V / 50 Hz
Motor / motor:	4,90CV - 3,6 Kw
Corriente / current consumption:	16 A
Presión max. / max. pressure:	100 bar.
Revoluciones / speed:	1.450 r.p.m.
Caudal/ flow:	13 l/min. max.
Dimensiones / dimensions:	650 x 500 x 700 mm.
Peso / Weight:	45 kg.



Alojamiento para diferentes toberas.
Housing for different nozzles.

Asa engomada para un mejor agarre.
Rubber coated handle for better grip.

Carrete para la manguera de 20 m. que facilita su utilización en cualquier lugar.
Reel for 20 m long hose for easy use at any place.

Manivela para una recogida fácil y cómoda de la manguera.
Crank handle for easy coiling of the hose.

Tobera 4 chorros.
Jet spray, 4 holes.

Ruedas con cámara de aire para un fácil transporte y uso en escaleras.
Pneumatic tyres for easy transport and use in stairs.

Botón de encendido con protección antisalpicaduras.
Splash proof ON/OFF button.

Pomo de regulación de presión sin escalonamiento, garantiza un funcionamiento fiable y una limpieza eficaz.
Infinitely variable pressure control knob guarantees reliable operation and effective cleaning.

Bomba de fácil acceso para un mantenimiento rápido.
Easy access to pump parts for quick maintenance.

Entrada de agua con sistema de acople rápido.
Quick connect water intake system.

Guía de la manguera.
Hose guide.

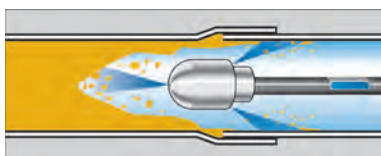

No.



SEH019000	Desatascadora agua a presión / High Pressure drain cleaning machine	1
Accesorios / Accessories		
76089	Tobera 4 chorros / Jet spray, 4 holes	1
76063	Tobera 5 chorros / Jet spray, 5 holes	1
77503	Tobera 45° giratoria, 4 chorros / Rotary nozzle 45°, 4 holes	1

Lined writing area with horizontal dashed lines.



Servicios generales

Destornilladores	74
Alicates	78
Sierras	81
Tijeras	83
Llaves ajustables	85
Juego de llaves de vaso de carraca	88
Llaves Allen	90
Discos de corte	91
Bolsa de herramientas y rodilleras	92
Obturadores neumáticos para tuberías y pozos	93

General purpose tools

<i>Screwdrivers</i>	74
<i>Pliers</i>	78
<i>Saws</i>	81
<i>Scissors</i>	83
<i>Adjustable wrenches</i>	85
<i>Combined socket sets</i>	88
<i>Allen wrenches</i>	90
<i>Cutting discs</i>	91
<i>Tool bag and kneepads</i>	92
<i>Pneumatic plugs for pipes and wells</i>	93

Destornilladores bimateriales

Destornilladores profesionales para el uso en bricolaje, mecánica, trabajos de mantenimiento.

Varilla cilíndrica fabricada al cromo vanadio.
Transmisión óptima del par de apriete a la punta del destornillador.

Screwdrivers bimateriales

Professional screwdrivers for bricolage, mechanic and maintenance works.

Chrome-vanadium cylindrical shank.
Optimum tightening torque transmission to screwdriver's tip.



Puntas negras para mayor precisión y protección contra la corrosión.

Black tips for a high precision and corrosion protection.

2

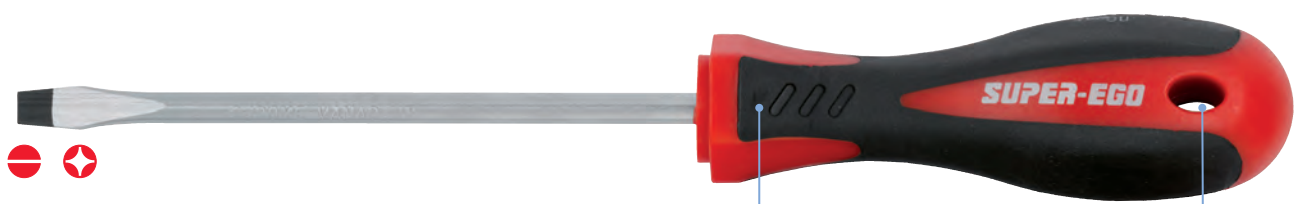

Mango bimaterial, ergonómico y antideslizante.
Mango sobredimensionado para un mejor trabajo.

Bimaterial, ergonomic and non-slip handle.
Oversized handle for a better work.

Agujero para colgar.

Hanging hole.



Zona inferior del mango más reducida para un trabajo más preciso.

Reduced lower part of the handle for more precise work.

Cabeza giratoria para un uso más preciso.

Rotating head for more precise use.

Destornilladores resistentes para trabajos mecánicos.

Strong screwdrivers for mechanical work.



Destornilladores de precisión para trabajos de electrónica, ordenadores, relojería

Precision screwdrivers for electronic, computer, watchmaking ... work.



Punta magnética tratada que garantiza una excelente sujeción a la cabeza del tornillo.

Hardened magnetic tip that ensures excellent hold of the screw head.









Destornilladores



No.	 
-----	---

Presentación individual

SEH010000	 3 x 75 mm	•	1
SEH010700	 5 x 100 mm	•	1
SEH010900	 5 x 150 mm	•	1
SEH011700	 PH0 x 75 mm	•	1
SEH011900	 PH1 x 100 mm	•	1
SEH012200	 PH2 x 125 mm	•	1

Pack 2 destornilladores PH / Pack 2 screwdrivers PH

1500000628	•	1
------------	---	---

Pack 6 destornilladores PH



SEH009300	•	1
-----------	---	---

Screwdrivers







Presentación / Product display



No. 1500000628

-  6 x 125 mm
-  PH2 x 125 mm

No. SEH009300

-  5 x 150 mm
-  5 x 100 mm
-  3 x 75 mm
-  PH0 x 75 mm
-  PH1 x 100 mm
-  PH2 x 125 mm

Pack destornilladores de precisión

Presentado en estuche de plástico para su almacenamiento.



No.	 
-----	---







SEH009400	•	1
-----------	---	---

Precision screwdrivers set

In plastic case for storage.

Presentación / Product display



-  1,5 x 50 mm
-  2 x 50 mm
-  2,5 x 50 mm
-  PH00 x 50 mm
-  PH0 x 50 mm
-  PH1 x 50 mm

No. SEH009400

Pack

Compuesto por 7 destornilladores, 10 destornilladores de precisión, 9 llaves de vaso, 15 puntas imantadas de 25 mm, adaptador y mango. Presentado en estuche de plástico para su almacenamiento.



No.	 
-----	---

SEH003100	•	1
-----------	---	---



Pack



Included: 7 screwdrivers, 10 precision screwdrivers, 9 sockets, 15 magnetic tips 25 mm, adaptor and handle. In plastic case for storage.

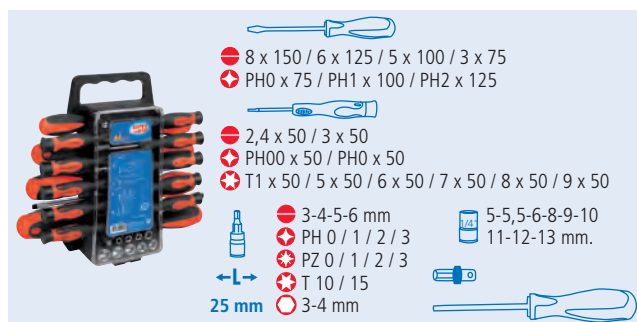







Presentación / Product display



-  8 x 150 / 6 x 125 / 5 x 100 / 3 x 75
-  PH0 x 75 / PH1 x 100 / PH2 x 125

-  2,4 x 50 / 3 x 50
-  PH00 x 50 / PH0 x 50
-  T1 x 50 / 5 x 50 / 6 x 50 / 7 x 50 / 8 x 50 / 9 x 50

-  3-4-5-6 mm
-  PH 0 / 1 / 2 / 3
-  PZ 0 / 1 / 2 / 3
-  T 10 / 15
-  3-4 mm
-  5-5,5-6-8-9-10
-  11-12-13 mm.

Conjunto destornilladores ERGO-MAX

Resistente a aceites y productos químicos.
Varilla de acero especial 73 MoV 5-2 y tratada (58HRc).
Punta magnética.

Screwdrivers ERGO-MAX set

Resistant to oil and chemicals.
Shank in special hardened alloy steel 73 MoV 5-2 (58HRc).
Magnetic tip.

Punta negra para mayor precisión y protección contra la corrosión.

Black tip for a high precision and corrosion protection.



Mango ergonómico bimaterial de polímeros. Mango sobredimensionado para un mejor trabajo.

Ergonomic bi-material polymer grip. Oversized handle for a better work.

Presentación / Product display



No. F20235000

- ME 3,5 x 75 mm
- ME 4 x 100 mm
- MF 5,5 x 125 mm
- MF 6,5 x 150 mm
- PH 1
- PH 2



No. F20236000

- ME 3,5 x 75 mm
- ME 4 x 100 mm
- MF 5,5 x 125 mm
- MF 6,5 x 150 mm
- PZ 1
- PZ 2



No.			
F20235000	Phillips Set	•	1
F20236000	Pozidriv Set	•	1

Conjuntos de destornilladores

Destornilladores con mango bimaterial, ergonómico y antideslizante. Mango sobredimensionado para un mejor trabajo.
Hoja al cromo vanadio.
Punta magnética.
Agujero para colgar.
Presentación en estuche colgante.

Screwdrivers sets

Screwdrivers with bimaterial, ergonomic and non-slip handle. Oversized handle for a better work.
Chrome-vanadium shank.
Magnetic tip.
Hanging hole.
Display in hanging case.



Conjunto de 6 destornilladores / 6 Screwdrivers sets

No.			
F09010600	Conjunto de 6 destornilladores / 6 Screwdrivers sets	•	6

Conjunto de 8 destornilladores / 8 Screwdrivers sets

No.			
F09010800	Conjunto de 8 destornilladores / 8 Screwdrivers sets	•	6

Presentación / Product display

- ME 3,5 x 75 mm
- ME 4 x 80 mm
- MF 5,5 x 125 mm
- MF 6,5 x 150 mm
- PH 1
- PH 2

No. F09010600



Presentación / Product display

- ME 3 x 75 mm
- ME 4 x 80 mm
- ME 5,5 x 125 mm
- ME 6,5 x 150 mm
- PH 1
- PH 2
- PZ1 x 80 mm
- PZ2 x 100 mm

No. F09010800



Conjuntos destornilladores electricista

Destornilladores de electricista, 1000 V.
Incluye destornillador testador.

Electrician screwdriver sets

Electrician screwdriver. 1000 V.
Includes tester screwdriver.



Punta negra para mayor precisión y protección contra la corrosión.

Black tip for a high precision and corrosion protection.

Mango bimaterial, ergonómico y antideslizante.
Mango sobredimensionado para un mejor trabajo.

Bimaterial, ergonomic and non-slip handle.
Oversized handle for a better work.



Varilla recubierta de material aislante.

Shank covered with insulating material.

Agujero para colgar.

Hanging hole.



Capacidad: 100-250 V.

Capacity: 100-250 V.



No.



1500000629	2 destornilladores + tester / 2 screwdrivers + tester	•	1
1500000671	4 destornilladores + tester / 4 screwdrivers + tester	•	1

Destornilladores seguros para trabajos eléctricos.
Safe screwdrivers for electric works

Tester para comprobación.
Tester for testing

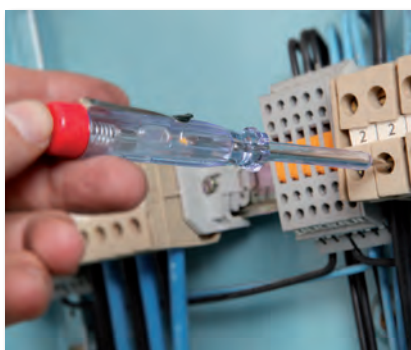

Presentación / Product display



No. 1500000629

- ME 4 x 100 mm
- PH 1 x 80 mm



No. 1500000671

- A3 5,5 x 125 mm
- A4 4 x 100 mm
- B2 PH2 x 100 mm
- B3 PH1 x 80 mm



Dureza de 58-62 Hrc en alicates de corte.

58-62 HRC hardness in cutting pliers.

Mangos bimaternal ergonómicos.

Ergonomic bi-material handles.

Superficie pulida.
Polished surface.

Acero al cromo-vanadio. Aporta una mayor vida útil y resistencia.

Chrome vanadium steel. Increased durability and strength.

Mangos con gran adherencia que evitan el deslizamiento, permitiendo un agarre preciso donde se ejerce la fuerza.

High adherence handles prevent slippage for precise grip where force is applied.



2

Universal

Bocas semi-planas para múltiples aplicaciones cortar, apretar, torcer ...
Dispone de zona para agarrar piezas redondas, cables ... y zona de corte.

Universal

Half flat nose for multiple applications: cutting, tightening, twisting ...
Features area to hold round parts, cables ... and cutting area.



Corte

Para cortar: cables, alambres, tornillos de diámetro pequeño ...

Corte

To cut: cables, wires, small diameter screws...



Corte lateral



Corte frontal

Pelacables

Para eliminar el aislante de los cables conductores. Tuerca para el ajuste al diámetro del cable.

Wire stripper

To remove the insulation of insulated conductors. Adjusting nut to suit the cable diameter.



Boca plana

Boca ligeramente estriada en su interior para doblar alambre, sujetar pequeñas piezas ...

Flat nose pliers

Finely corrugated nose to bend wire, hold small parts ...



Para teléfonos

Bocas semi-planas para agarrar, doblar cables eléctricos, alambres ...
Cabeza alargada para acceso a espacios reducidos. Disponen de zona para el corte de hilo, cables finos y zona de agarre (L: 200 mm)

Wire stripper

Half flat nose to hold, bend electrical cables, wires... Long nose for access to confined spaces. Features area to cut wire threads, fine cables.... and hold area (L: 200 mm)



Punta redonda

Para doblar alambres y hacer cadenas.

Round nose



To bend wires and make chains.



Presentaciones / Product display



No. 514010000

No.		kg.		
514010000	Universal / Universal 160 mm	0,3	•	6
514010100	Universal / Universal 180 mm	0,3	•	6
514010200	Universal / Universal 200 mm	0,3	•	6
514011100	Corte lateral / Side-cutting 160 mm	0,3	•	6
514011200	Corte lateral / Side-cutting 180 mm	0,3	•	6
514010300	Boca redonda / Round nose 160 mm	0,3	•	6
514010400	Boca plana / Flat nose pliers 160 mm	0,3	•	6
514011500	Corte frontal / End cutting pliers 160 mm	0,3	•	6
514010500	Para teléfonos / Long nose pliers 160 mm	0,3	•	6
514010700	Para teléfonos / Long nose pliers 200 mm	0,3	•	6
514011000	Boca curva / Bent nose 200 mm	0,3	•	6
514011400	Pelacables / Wire stripper 160 mm	0,3	•	6

Alicates de electricista / Electrician pliers



Idóneos para electricistas profesionales
Para sujetar material, doblar, cortar, pelar ..., protegidos para su uso en trabajos con tensión hasta 1.000 V.

Ideal for professional electricians
For holding materials, bending, cutting, stripping, protected for work under voltage up to 1,000V in pipe installation and maintenance.

Dureza de 58-62 Hrc en alicates de corte.

58-62 HRC hardness in cutting pliers.



Superficie pulida.

Polished surface.

Fabricado en Acero al Cromo-Vanadio (Cr-V) que prolonga su durabilidad y mejora su resistencia.

Built in Chrome vanadium (Cr-V) steel: enlarged durability and improved resistance.

Mango bimaterial de alta adherencia previene su deslizamiento y su diseño ergonómico facilita su uso.

Bimaterial handle with high adherence prevents from slipping. Ergonomic design: easy to use.

Universal

Bocas semi-planas para múltiples aplicaciones: agarrar, cortar o doblar cables eléctricos, alambres ... Dispone de zona para agarrar piezas redondas, cables ... y zona para el corte de hilo, cables finos

Universal

Half flat nose for multiple applications: hold, cut or bend electrical cables, wires ... Features: area to hold round parts, cables ... and area to cut wire threads, fine cables.



Para teléfonos

Bocas semi-planas para agarrar, doblar cables eléctricos, alambres ... Cabeza alargada para acceso a espacios reducidos. Disponen de zona para el corte de hilo, cables finos y zona de agarre (L: 200 mm)

Wire stripper

Half flat nose for to hold, bend electrical cables, wires... Long nose for access to confined spaces. Features: area to cut wire threads, fine cables ... and hold area (L: 200 mm).



Corte lateral

Para cortar: cables, alambres Cabeza estrecha, facilita el acceso a espacios reducidos.

Side-cutting

To cut: cables, wires ... Narrow nose for access to confined spaces.



Boca curva

Bocas semi-planas curvadas para agarrar, doblar cables eléctricos, alambres ... Cabeza alargada para acceso a espacios reducidos. Disponen de zona para el corte de hilo, cables finos y zona de agarre.

Bent nose

Bent half flat nose to hold, bend electrical cables, wires... Long nose for access to confined spaces. Features: area to cut wire threads, fine cables ... and hold area.



Pelacables

Para eliminar el aislante de los cables conductores. Tuerca para el ajuste al diámetro del cable.

Wire stripper

To remove the insulation of insulated conductors. Adjusting nut to suit the cable diameter.

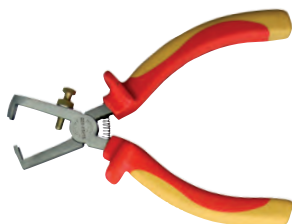

Presentaciones / Product display



No. SEH004200



No.



SEH004200	Universal / Universal 160 mm	•	1
SEH004300	Corte lateral / Side-cutting 160 mm	•	1
SEH004400	Pelacables / Wire stripper 160 mm	•	1
SEH004500	Para teléfonos / Long nose pliers 160 mm	•	1
SEH009800	Para teléfonos / Long nose pliers 200 mm	•	1
SEH009900	Boca curva / Bent nose 200 mm	•	1



Juego de 4 alicates

Incluye alicate universal, alicate de corte diagonal, alicate para teléfonos de boca curva y alicate pelacables.



4 piece plier set

Set composition: 1 universal plier + 1 side-cutting plier + 1 long nose plier + 1 wire stripper plier.

No.		
S51404000	•	1

Juego 2 alicates con tenaza de canal

Incluye: alicate universal 160 mm, alicate corte diagonal 160 mm y tenaza de canal 522 - 10".





2 piece pliers and waterpump plier set

Set composition: 1 universal plier 160mm + 1 side-cutting plier 160mm + 1 waterpump plier 10" (522-10").

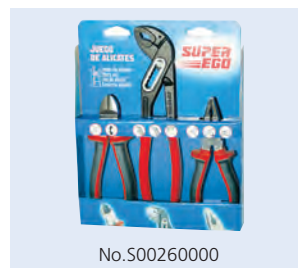
Presentaciones / Product display



No.S00260000

No.		
S00260000	•	1



Juego de 6 minialicatos

Incluye alicates de electricista de boca redonda, boca semi-redonda, punta curva, boca plana, corte diagonal, corte frontal y boca semi-redonda con corte.

6 mini-pliers set

Set composition: Round nose plier, end cutting, long nose, side cutters, flat nose plier and top cutter.



No.		
S51406000	•	1

Sierra mini

Para cortes en lugares de difícil acceso.
Mango ergonómico.

Presentaciones / Product display

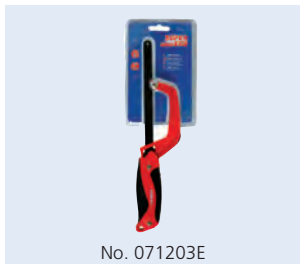

No. 071203E

No.



071203E

1

Mini hacksaw

Hacksaw to be used in small confined areas.
Ergonomic handle.

DATOS TECNICOS / TECHNICAL DATA

Longitud de la hoja / length blade:	10"
Anchura de la hoja / width blade:	1/2"
Número de dientes / number tooth:	24 tpi



Arco de sierra 170

Mango de aleación especial de aluminio.
Compacto y robusto.

Se puede guardar una hoja de repuesto en el arco y el giro de la hoja a 90° permite el corte de lado.

Presentaciones / Product display



No. 170000000

No.



170000000

10

Hacksaw frame 170

Handle made of light aluminium alloy.
Compact and robust.

A spare blade can be stored in the bow and the blade can be turned 90° for side cutting.

DATOS TECNICOS / TECHNICAL DATA

Longitud de la hoja / length blade:	12"
Anchura de la hoja / width blade:	1/2" - 1"
Número de dientes / number tooth:	24 tpi

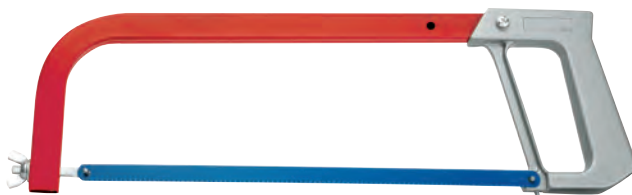

Arco de sierra PRO 17010

Arco de sierra Alta Tensión.
Mango de aleación especial de aluminio.

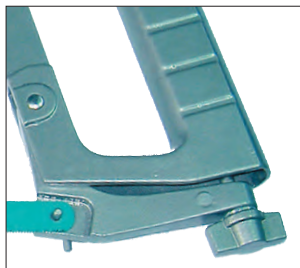
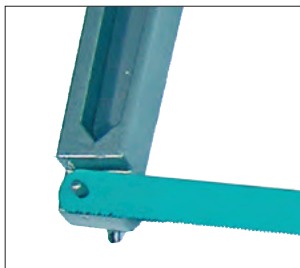

No.



170100000

10

Hacksaw frame PRO 17010

High tensile strength hacksaw frame.
Special aluminium alloy handle.

DATOS TECNICOS / TECHNICAL DATA

Longitud de la hoja / length blade:	12"
Anchura de la hoja / width blade:	1/2" - 1"
Número de dientes / number tooth:	24 tpi



Hojas de sierra bimetálica

Para su utilización con la sierra MINI y los arcos de sierra 170 y 17010.

Saw blades bimetal

Saw blades for MINI hacksaw and hacksaws 170 and 17010.



DATOS TECNICOS / TECHNICAL DATA

Longitud de la hoja / length blade:	12"
Anchura de la hoja / width blade:	1/2"
Número de dientes / number tooth:	24 tpi

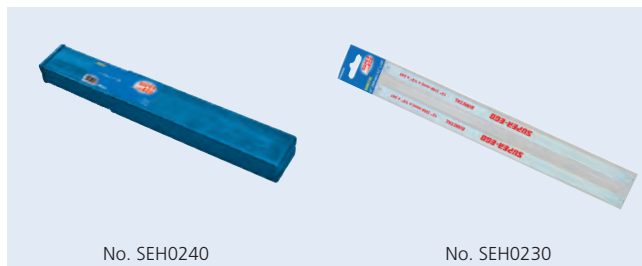

Presentaciones / Product display



No.			
SEH0240	Hoja de sierra bimetálica / Saw blade bimetal		100
SEH0230	Pack 2 hojas de sierra bimetálica / Pack 2 saw blade bimetal	•	1

Hojas de sierra de carbono

Para su utilización con los arcos de sierra 170 y 17010.

High carbon steel hacksaw blades

For hacksaw frames 170 and 17010.

DATOS TECNICOS / TECHNICAL DATA

Longitud de la hoja / length blade:	12"
Anchura de la hoja / width blade:	1"
Número de dientes / number tooth:	24 tpi



Presentaciones / Product display



No.		
SEH0229	Hoja de sierra carbono / Carbon steel hacksaw blades	50

Hojas de sierra de carbono

Para su utilización con la sierra MINI y los arcos de sierra 170 y 17010.

High carbon steel hacksaw blades

Saw blades for MINI hacksaw and hacksaws 170 and 17010.

DATOS TECNICOS / TECHNICAL DATA

Longitud de la hoja / length blade:	12"
Anchura de la hoja / width blade:	1/2"
Número de dientes / number tooth:	24 tpi



Presentaciones / Product display



No.		
1500000468	Hoja de sierra carbono / Carbon steel hacksaw blades	100

Tijeras multiusos profesionales

Indispensable en la mayoría de trabajos, para el corte de: cuero, moqueta, chapa de poco grosor.

Hoja micro dentada con orificio pelacables.

Cuerpo ergonómico provisto de grip antideslizante para un mayor agarre.

DATOS TECNICOS / TECHNICAL DATA

Longitud de la hoja / Blade length: **58 mm**
Longitud / Length: **202 mm**

Professional multipurpose scissors

A must for most works, for cutting: leather, carpet, thin sheetmetal.

Micro-serrated blade with cable stripping hole.

Non slip ergonomic handle for better grip.



Presentaciones / Product display

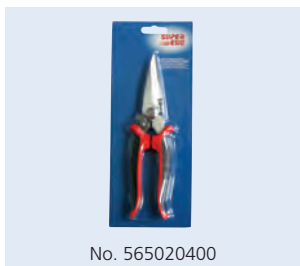

No. 565020400



No.



565020400

Tijeras multiusos / Multipurpose scissors

•

1

Tijeras universales

Tijeras bimateriales resistentes para el corte de gran variedad de materiales, de gran utilidad y confort.

Dispone de una hoja micro dentada con orificio pelacables y provistas de cascanueces.

DATOS TECNICOS / TECHNICAL DATA

Longitud de la hoja / Blade length: **76 mm**
Longitud / Length: **195 mm**

Universal scissors

Resistant bi-material scissors for a great variety of cuts, extremely useful and comfortable to use.

Micro-serrated blade with cable stripping hole and nut crusher.



Presentaciones / Product display

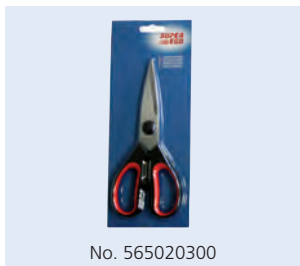

No. 565020300



No.



565020300

Tijera universal / Universal scissor

•

1

Tijeras electricista

Diseñada para el electricista, para corte y pelado de cables gracias al orificio de una de sus hojas.

Para un corte preciso como para grandes requerimientos con un sorprendente confort de utilización.

Hojas de acero inoxidable y hojas de corte microdentadas para una mayor sujeción durante el corte.



Electrician scissors

Specially designed for electrician work, cable cutting and stripping thanks to the hole in one of the blades.

Designed both for accurate cuts and high performance amazingly comfortable to use.

Stainless steel blades and micro-serrated edge for better hold during the cutting process.

DATOS TECNICOS / TECHNICAL DATA

Longitud de la hoja / Blade length: 42 mm
 Longitud / Length: 144 mm

Presentaciones / Product display

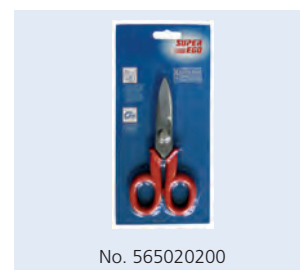

No. 565020200

No.



565020200	Tijera electricista / Electrician scissor	•	1
-----------	---	---	---

Tijeras electricista bimaterial

Especialmente diseñada para el electricista, para corte y pelado de cables gracias al orificio.

Hojas de acero inoxidable y cuerpo ergonómico bi-material para un máximo agarre.

Hoja microdentada para una mayor sujeción durante el corte.



Two-component electrician scissors

For electrician work, cable cutting and stripping thanks to the hole in one of the blades.

Stainless steel blades and ergonomic two-component handle for maximum grip.

Micro-serrated edge for better hold during the cutting process.

DATOS TECNICOS / TECHNICAL DATA

Longitud de la hoja / Blade length: 42 mm
 Longitud / Length: 144 mm

Presentaciones / Product display

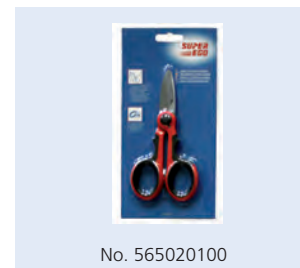

No. 565020100

No.



565020100	Tijera electricista / Electrician scissor	•	1
-----------	---	---	---

Llave ajustable 135

Forjada en acero especial.
Cromada.
Escala en mm y pulgadas.
Robustez y duración garantizadas.

Adjustable wrench 135

Forged in special steel.
Chrome plated.
Scale in mm and inches.
Guaranteed robustness and long life.

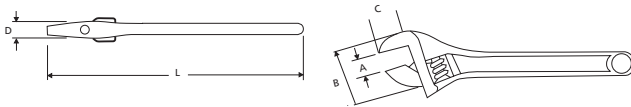

No.	L in.	A mm	B mm	C mm	D mm	kg		
135060000	6	19	47	18	10,5	0,1	•	6
135080000	8	24	58	23	13	0,2	•	6
135100000	10	30	71	28	15	0,3	•	6
135120000	12	34	84	36	18	0,6	•	6
135150000	15	44	104	44	22	1,1	•	1

Presentaciones / Product display



No. 135120000

Llave ajustable gran apertura

Fabricadas en acero especial.
Escala en milímetros y pulgadas.
Mango de tacto suave para un agarre más seguro.
Bocas más largas y delgadas.
Robustez y duración garantizadas.

Wide opening adjustable wrench

Forged in special steel.
Scale in mm and inches.
Smooth handle for better grip.
Jaws longer and thinner.
Guaranteed robustness and long life.



Presentaciones / Product display



No. 150000670

No.	L in.	Ø mm		
150000670	8	40	•	1
SEH019200	10	52	•	10

Juego de llaves fijas

Fabricadas en acero al cromo vanadio.
Acabado mate.
Dureza: 42-48 HRC.

Double open end spanner set

Made of chrome-vanadium.
Matt finish.
Hardness: 42-48 HRC.



Presentaciones / Product display



No. SEH001000



Conjunto: 8 llaves fijas 6-7, 8-9, 10-11, 12-13, 14-15, 16-17, 18-19, 20-22 mm en soporte para su almacenamiento y exposición.
Set: 8 double open end spanner 6-7, 8-9, 10-11, 12-13, 14-15, 16-17, 18-19, 20-22 mm in box for stockage and exposition.

No.		
SEH001000	•	1

Juego de llaves estrella acodadas

Fabricadas en acero al cromo vanadio.
Acabado mate.
Dureza: 42-48 HRC.

Double ended ring spanner

Made of chrome-vanadium.
Matt finish.
Hardness: 42-48 HRC.



Presentaciones / Product display



No. SEH001100



Conjunto: 8 llaves estrella acodadas s 6-7, 8-9, 10-11, 12-13, 14-15, 16-17, 18-19, 20-22 mm en soporte para su almacenamiento y exposición.
Set: 8 double ended ring spanner 6-7, 8-9, 10-11, 12-13, 14-15, 16-17, 18-19, 20-22 mm in box for stockage and exposition.

No.		
SEH001100	•	1

Juego de llaves combinadas

Fabricadas en acero al cromo vanadio.
Acabado mate.
Dureza: 42-48 HRC.

Combination wrench set

Made of chrome-vanadium.
Matt finish.
Hardness: 42-48 HRC.



Presentaciones / Product display



No. SEH001200



Conjunto: 12 llaves combinadas 6-9-10-11-12-13-14-15-17-18-19-21 mm en soporte para su almacenamiento y exposición.
Set: 12 combination wrenches 6-9-10-11-12-13-14-15-17-18-19-21 mm in box for stockage and exposition.

No.		
SEH001200	•	1

Juego de llaves combinadas con carraca

Con tratamiento térmico.
Cromadas.
Presentación brillante.

Combination open end & ratchet wrench set

Heat treated.
Chrome plated.
With "mirror" polished finishing.



Presentaciones / Product display



No. SEH001300

Conjunto: 8 llaves combinadas con carraca 8-10-11-13-14-17-19-22 mm en soporte para su almacenamiento y exposición.

Set : 8 combination open end & ratchet wrenchs 8-10-11-13-14-17-19-22 mm in box for stockage and exposition.

No.



SEH001300 | 8 Llaves con carraca / 8 open end & ratchet wrenches | • | 1



Juego de llaves combinadas con carraca articuladas

Con tratamiento térmico.
Cromadas.
Presentación brillante.

Combination open end & ratchet handle set

Heat treated.
Chrome plated.
With "mirror" polished finishing.



Carraca articulada
Flexible ratchet

Presentaciones / Product display



No. SEH001400

Conjunto: 7 llaves con carraca articulada 8-10-11-13-14-17-19 mm en soporte para su almacenamiento y exposición.

Set: 7 combination open end & flexible ratchet handle 8-10-11-13-14-17-19-22 mm in box for stockage and exposition.

No.



SEH001400 | 7 Llaves con carraca articulada / 7 open end & flexible ratchet handle | • | 1





Imprescindibles en trabajos de mecánica

Herramienta necesaria para montar o desmontar tuercas, tornillos que puedan estar con un acceso difícil. Los set de llaves de vaso presentan un abanico de medidas para diferentes aplicaciones.

A must for mechanical work

This tool is needed for nut and screw installation and removal in places with difficult access. Socket wrench sets include a wide range of sizes for different applications

2

Juegos de llaves de vaso

Combined socket sets

Fabricado en Acero al Cromo-Vanadio CR-V 50BV30. Terminación cromada acabado mate.

Manufactured in Chrome-Vanadium CR-V 50BV30. Chrome plated and matte finish.

Carraca reversible de 72 dientes. Recuperación 5% por diente. Con inversor ergonómico.

72 teeth reversible ratchet. 5% teeth recovery. With ergonomic lever.



Se presentan en práctica maleta de plástico.

Handy plastic carrying case.

Vasos hexagonales de 1/4" con aristas redondeadas, forjados en frío.

Cold forged 1/4" Hexagon sockets, round edges.

Presentaciones / Product display





No. SEH00900







Juegos de llaves de vaso. 46 piezas















Combined socket sets. 46 pieces













1/4"  

4"  2" 



4x  

21x              

-  3-4-5-6-7-8 mm
-  PH 1-2-3
-  PZ 1-2-3
-  4-5,5-7 mm
-  T 10-15-20-25-30-40 mm

13x      



-  4-4,5-5-5,5-6-7-8-9-10-11-12-13-14 mm



No.	 
SEH000700	Set 46 piezas / Set 46 pieces















Juegos de llaves de vaso. 58 piezas





Combined socket sets. 58 pieces









3/8"  







10"  3" 

24x              



-  3-4-5-6-7-8-10 mm
-  PH 1-2
-  PZ 1-2-3
-  4-5,5-7 mm
-  T 10-15-20-25-30-40-45-55 mm

18x      



-  6-7-8-9-10-11-12-13-14-15-16-17-18-19-20-21-22-24 mm

9x      

-  8-10-11-12-13-14-15-17-19 mm

2x  

-  16-21 mm



No.	 
SEH000800	Set 58 piezas / Set 58 pieces



Juegos de llaves de vaso. 94 piezas

















Combined socket sets. 94 pieces

















3x 





1/4"  





4"  2" 

17x                 





-  3-4-5-6 mm
-  PH 1-2
-  PZ 1-2
-  4-5,5-7 mm
-  T 8-10-15-20-25-30 mm

15x          



-  8-10-12-14 mm
-  PH 3-4
-  PZ 3-4
-  8-10-12 mm
-  T 40-45-50-55 mm



13x     



















-  4-4,5-5-5,5-6-7-8-9-10-11-12-13-14 mm

8x    



-  6-7-8-9-10-11-12-13 mm

1/2"  



10"  5" 

18x                  



-  10-11-12-13-14-15-16-17-18-19-20-21-22-23-24-27-30-32 mm

4x   



-  14-15-17-19 mm

2x  

-  16-21 mm

-  3/4" x 1/2" 8 mm

No.	 
SEH000900	Set 94 piezas / Set 94 pieces



Llaves Allen
 Herramienta de amplio uso desde la mecánica, montaje de mobiliario, bricolaje Necesaria para atornillar y desatornillar los tornillos de cabeza hexagonal hueca o cabeza Allen.

Allen wrench
 This tool covers many uses, from mechanical applications to furniture assembling, DIY ... Needed to screw and unscrew hexagonal socket head or Allen head screws.

2

Juego de llaves Allen con Torx inviolable

Fabricadas al cromo vanadio con tratamiento térmico.
 Compuesto por 18 piezas:
 - 9 puntas Allen: 1,5-2-2,5-3-4-5-6-8-10 mm.
 - 9 puntas Torx/Torx inviolable: 10-15-20-25-27-30-40-45-50 mm.

Allen wrench set with tamper proof

Made of chrome vanadium steel with heat treated
 Contains 18 pieces:
 - 9 Allen tip: 1,5-2-2,5-3-4-5-6-8-10 mm.
 - 9 Torx/tamper proof torx: 10-15-20-25-27-30-40-45-50 mm.

Presentación / Product display



No.		
SEH003200	•	1

Llaves Allen

Fabricada en acero al cromo-vanadio con tratamiento térmico.
 Dos conjuntos: llaves cortas y llaves largas con punta bola hexagonal para el acceso a la cabeza del tornillo en lugares de difícil acceso.
 - 9 llaves: 1,5-2-2,5-3-4-5-6-8-10 mm.

Allen wrenches

Made of heat treated chrome-vanadium alloy steel.
 Two sets: short and long wrenches with hexagonal ball end to access the screw head in concealed spaces.
 - 9 wrenches: 1,5-2-2,5-3-4-5-6-8-10 mm.

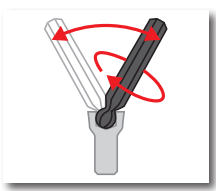
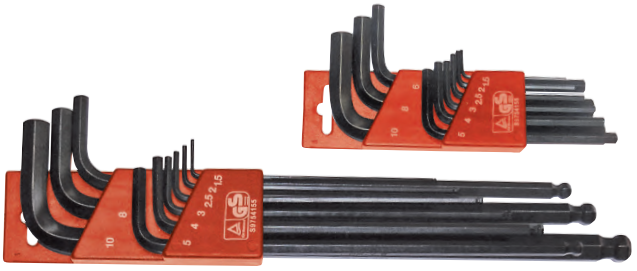

No.		
B40224300	Cortas / Short	• 10
B40234300	Largas punta bola hexagonal / Long punta bola hexagonal	• 10

Llaves Allen

Fabricada en acero al cromo-vanadio, con tratamiento térmico.

Allen wrenches

Made of heat treated chrome-vanadium alloy steel.

Presentaciones / Product display

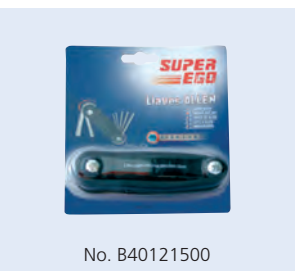

No.		
B40121300	1,5 - 6 mm Ø	• 10
B40121500	2,5 - 10 mm Ø	• 10

Discos de corte metal

Corte veloz de todo tipo de metales.

DATOS TECNICOS / TECHNICAL DATA

Aplicaciones / Application: **Metal**
Grosor / Thickness : **3 mm**

No.			
855115100	115 x 3 x 22,2 mm	50	
855230100	230 x 3 x 22,2 mm	50	

Metal cutting discs

Fast cutting of all types of metals.



Discos de corte metal ULTRA

Corte veloz de todo tipo de metales-inox.

Construidos con reforzamientos especiales, resinas super elásticas y abrasivos de alta calidad.

DATOS TECNICOS / TECHNICAL DATA

Aplicaciones / Application: **Metal-Al**
Grosor / Thickness : **1,6 mm**

No.			
855115200	115 x 1,6 x 22,2 mm	50	
855125200	125 x 1,6 x 22,2 mm	50	

Metal cutting discs ULTRA

Fast cutting of all types of stainless metals.

Made with special reinforcements, extra elastic resins and high quality abrasives.





Discos de metal-inox SUPER-CUT

Corte rápido de todo tipo de metales e inox (redondo, laminado, cuadrado, tubo ...). La más alta calidad, velocidad y seguridad en el corte.

Con refuerzos especiales en fibra de vidrio, resinas especiales y materiales abrasivos especialmente seleccionados.

DATOS TECNICOS / TECHNICAL DATA

Aplicaciones / Application: **Metal-Al**
Grosor / Thickness : **1 mm**

No.				
855115700	115 x 1 x 22,2 mm	50		
P85510500	115 x 1 x 22,2 mm 5 discos / discs	1	•	
855125700	125 x 1 x 22,2 mm	50		

Stainless metal discs SUPER-CUT

Fast cutting of all types of metals and stainless steel (rods, rolled rectangular bars, tubes...). The highest cutting quality, speed and safety.

With special glass fibre reinforcements, special resins and specially selected abrasive materials.



Presentaciones
Product display

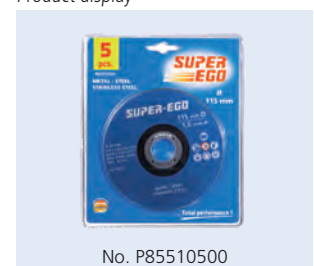

No. P85510500

Bolsa de herramientas + 2 rodilleras

Ideal para transportar todo tipo de herramientas

Estructura abierta con paredes rígidas para un rápido acceso a las herramientas. 40 alojamientos: 30 bolsillos y 10 cintas elásticas.

EXTERIOR: Base reforzada con plástico rígido para evitar el contacto con superficies sucias o húmedas y amortiguar golpes. Asa central de aluminio con empuñadura de caucho para facilitar el transporte.

INTERIOR: Módulo interior extraíble con velcro con: 10 bolsillos y 10 alojamientos elásticos.

RODILLERAS: Para uso en todo tipo de suelos. Núcleo de gel y aire inyectado que absorbe golpes y proporciona una comodidad duradera. Sistema de cierre de velcro para mayor comodidad, ajuste y durabilidad.



Tool bag + 2 kneepads

Ideal to carry all types of tools.

Open structure with rigid walls for quick access to the tools. 40 tool holders: 30 pockets and 10 elastic straps.

OUTSIDE: Rigid plastic reinforced base to prevent contact with dirty or moist surfaces and to cushion impacts. Central aluminium handle with rubber grip for easy carrying.

INSIDE: Removable internal module with velcro consisting of a total of 10 pockets and 10 elastic housings.

KNEEPADS: For use in all types of floors. Shock absorbing air injected gel core for durable comfort. Velcro closure for greater ease, better fit and durability.

DATOS TECNICOS / TECHNICAL DATA

Dimensiones / dimensions:	415 x 230 x 300 mm
Carga max. / maximum load :	15 kgs
Base reforzada / reinforced base :	SI / YES



No.



1500000466	Bolsa + 2 rodilleras / Bag + 2 Kneepads	1
------------	---	---

Rodilleras

Fabricada en caucho.

Evita molestias en los trabajos que se realizan de rodillas.



Kneepads

Manufactured in rubber

Avoids discomfort for those jobs where kneeling down is necessary.

No.



V39800000		1
-----------	--	---

Carro de aluminio

Fabricado en aluminio con estructura extensible en altura para una mayor comodidad en el uso, transporte y almacenaje.

Dispone de ruedas con rodamientos y bandeja inferior plegable.



Aluminium cart

Flexible structure for an easy use, transport and storage.

Wheels with bearings and folding tray.

DATOS TECNICOS / TECHNICAL DATA

Dimensiones / dimensions:	387 x 412 x 1.105 mm. 387 x 190 x 735 mm.
Peso / weight:	6,2 kgs
Carga max. / maximum load :	

No.



855092200		1
-----------	--	---

Obturadores neumáticos

El uso de obturadores neumáticos es el método más sencillo y práctico para taponar tuberías de forma fácil y eficaz. Consiste básicamente en un cilindro de goma hinchable que se introduce en la tubería. Al inflar el obturador, tapona la tubería presionando sus paredes y permitiendo un alto grado de adaptabilidad.

Aplicaciones:

Obtención/taponamiento de tuberías durante su construcción, reparación, etc.

Pruebas de estanqueidad de tuberías y pozos, tanto con agua como con aire a presión o vacío.

Características generales:

Utilización rápida, económica y fiable.

Corto tiempo de inflado.

Todos los obturadores están comprobados con un margen de seguridad de 1,3 veces sobre la presión nominal de trabajo.

Baja presión de inflado de 1,5 – 2,5 bar, aplicable incluso en tuberías que hayan perdido parte de su resistencia mecánica con el paso del tiempo. Alta resistencia química. Utilizable en gran rango de temperaturas, desde -5°C a +70°C

Obturadores MINI

Para tuberías domésticas con Ø 40 - 200 mm.

Los obturadores MINI están específicamente concebidos para aplicaciones en tuberías domésticas de pequeño diámetro.

Su pequeño tamaño y su gran facilidad de uso lo convierten en un accesorio imprescindible en las tareas de mantenimiento, limpieza, desatascos, inspección, reparaciones, etc., en el interior de edificios.

Pneumatic plugs

The use of pneumatic plugs is the most simple and practical method to easily and efficiently plug pipes. It basically consists of an inflatable rubber cylinder that is introduced into the pipe. When the plug is inflated, it plugs the pipe pressing on the pipe walls and allowing for a high degree of adaptability.

Applications:

Pipe plugging during construction, repairing, etc.

Tightness tests for water, pressure air or vacuum pipes and wells.

Características generales:

Quick, economical and reliable use.

Short inflating time.

All plugs are tested with a safety coefficient of 1.3 times the rated working pressure.

Low inflating pressure of 1.5 – 2.5 bar, applicable even to pipes that have lost part of their mechanical resistance by aging. High chemical resistance. Can be used in a large temperature range, from -5°C to +70°C

MINI plugs

For domestic pipes Ø 40 - 200 mm.

MINI plugs are specially designed for applications in small diameter domestic pipes.

Their small diameter and ease of use turn it into an essential accessory in maintenance, cleaning, clog clearing, inspection, repairing, etc. tasks, inside buildings.

Sólo para taponamiento / Only for blocking plug.

No.	Presión inflado Inflation pressure	Tipo type	Ø mm	
Q87860300	2,5 bar	Z2/3	50-75	1
Q87860400	2,5 bar	Z3/4	75-100	1
Q87860500	2,5 bar	Z4/6	100-150	1
Q87860600	2,5 bar	Z6/8	150-200	1
Q86002200	2,5 bar	Z1/Z2	33-40	1
Q87858200	2,5 bar	Z2	50	1

Para aplicaciones de by-pass y comprobación de estanqueidad / Bypass and leak test applications.

No.	Presión inflado Inflation pressure	Tipo type	Ø mm	
Q87860700	2,5 bar	S2	50	1
Q87676800	2,5 bar	S3	75	1
Q87677000	2,5 bar	S4	100	1
Q87677200	2,5 bar	S6	150	1
Q87861400	2,5 bar	S3/S4	75-100	1
Q87860900	2,5 bar	S4/6	100-150	1
Q87861000	2,5 bar	S6/8	150-200	1

Accesorios / Accessories.

No.	Presión inflado Inflation pressure	
Q87890500	Manguera de inflado. Inflating hose. 5 m	1
Q86001000	Bomba manual de inflado. Inflating manual pump	1



Obturadores para tuberías generales

Para tuberías generales con Ø 100 - 1500 mm.

Plugs

For customary municipal sewage pipes Ø 100 - 1.500 mm.

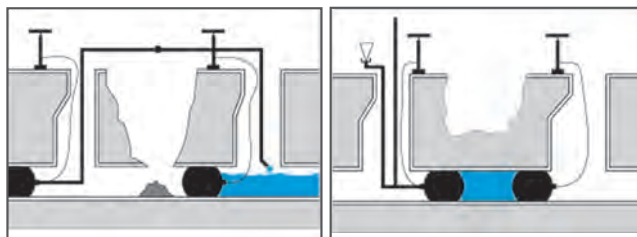
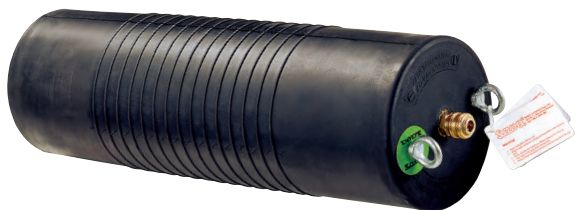

Sólo para taponamiento / Only for blocking plug.

No.	Presión inflado Inflation pressure	Tipo type	Ø mm	Ø x mm	Contrapres. bar	Kg.	
Q86041700	2,5 bar	N 100-200	100-200	92 x 535	2,3-1,3	1,1	1
Q86041800	2,5 bar	N 150-300	150-300	142 x 575	2,2-1,2	1,9	1
Q86041900	2,5 bar	N 200-400	200-400	192 x 635	2,2-1,2	3,0	1
Q86042200	2,5 bar	N 350-600	350-600	322 x 865	2,1-1,3	8,4	1
Q86045300	2,5 bar	N 500-800	500-800	472 x 1.185	1,8-1,1	17,3	1
Q86042500	1,5 bar	N 500-1000	500-1000	472 x 1.185	1,0-0,5	17,3	1
Q87895700	1,0 bar	N 600-1200	600-1200	560 x 1.800	1,0-0,5	55,0	1
Q87895900	1,0 bar	N 750-1500	750-1500	600 x 2.300	1,0-0,4	67,0	1

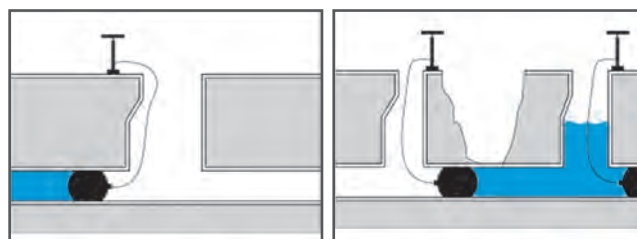

Taponamiento y by-pass / For blocking plug and by-pass.

No.	Presión inflado Inflation pressure	Tipo type	Ø mm	Ø x mm	Contrapres. bar	Kg.	
Q86042900	2,5 bar	BP 100-200	100-200	92 x 550	2,3-1,3	2,6	1
Q86043200	2,5 bar	BP 150-300	150-300	142 x 590	2,2-1,2	4,4	1
Q86043400	2,5 bar	BP 200-400	200-400	192 x 635	2,2-1,2	6,3	1
Q86044000	2,5 bar	BP 350-600	350-600	322 x 865	2,1-1,3	16,6	1
Q86045400	2,5 bar	BP 500-800	500-800	472 x 1.185	1,8-1,1	31,3	1
Q86044200	1,5 bar	BP 500-1000	500-1000	472 x 1.185	1,0-0,5	31,3	1
Q87895800	1,0 bar	BP 600-1200	600-1200	560 x 1.800	1,0-0,5	60,0	1
Q87896000	1,0 bar	BP 750-1500	750-1500	600 x 2.300	1,0-0,4	75,0	1



Accesorios / Accessories.

No.	Presión inflado Inflation pressure	
Q87426800	Manguera de inflado. <i>Inflating hose.</i> 10m.	1
Q86031000	Controlador de inflado. <i>Controller inflated.</i> 2,5 bar.	1
Q87460900	Controlador de inflado. <i>Controller inflated.</i> 1,5 bar.	1
Q87465300	Controlador de inflado. <i>Controller inflated.</i> 1 bar.	1



Soldadura

Sopletes a cartuchos desechables	100
Cartuchos desechables	104
Sopletes a manguera	105
Sopletes a manguera con conexión de espiga	106
Accesorios para butano/propano	107
Socket	110

Soldering

<i>Torches for disposable gas cartridges</i>	100
<i>Disposable gas cartridges</i>	104
<i>Hose connection torches</i>	105
<i>Handles with nipple connection hose</i>	106
<i>Butane/propane accessories</i>	107
<i>Socket</i>	110

Sopletes a cartucho / Torches for disposable gas cartridges

	SEGOFLAME	SEGOFLAME PIEZO	SEGOFIRE	SEGOFIRE PIEZO
Soldadura fuerte / Brazing	NO		hasta / up to 16 mm Ø	
Soldadura blanda / Soft soldering	hasta / up to 16 mm Ø		hasta / up to 22 mm Ø	
Quemador / Burner	22 mm Ø		22 mm Ø	
Conexión / Connection	Cartucho perforable / Pluggable cartridge		EU 7/16"	
Encendido PIEZO / PIEZO ignition	NO	SI / YES	NO	SI / YES
Regulador llama / Regulating valve	SI / YES		SI / YES	
Cartucho / Disposable gas cartridges	BTP C200 		BTP 300 	

Página / Page

100

100

101

101

	EASY FIRE	MULTIFIRE	SUPER-FOGO	POWER-FIRE Compact
Soldadura fuerte / Brazing	hasta / up to 15 mm Ø		hasta / up to 22 mm Ø	hasta / up to 28 mm Ø
Soldadura blanda / Soft soldering	hasta / up to 22 mm Ø		hasta / up to 28 mm Ø	hasta / up to 35 mm Ø
Quemador / Burner	22 mm Ø	22 mm Ø	16 mm Ø	16 mm Ø
Conexión / Connection	EU 7/16"	Universal / Universal	US 1"	US 1"
Encendido PIEZO / PIEZO ignition	SI / YES	SI / YES	-	SI / YES
Regulador llama / Regulating valve	SI / YES	SI / YES	SI / YES	SI / YES
Cartucho / Disposable gas cartridges	BTP 300 	BTN 250 	ROMASSGAS 	ROMASSGAS 

Página / Page

102

102

102

103

Cartuchos / Disposable gas cartridges

	BTP C200	BTN 250	BTP 300	ROMASSGAS
Conexión / Connection	Perforable / Dunch in	Universal / Universal	EU 7/16"	US 1"
Temperatura / Temperature	1.925 °C	1.925 °C	1.925 °C	2.600 °C
Tipo de soldadura / Soldering type	Blanda / Soft	Blanda / Soft	Blanda-fuerte / Soft-brazing	Fuerte / Brazing

Página / Page

104

104

104

104

Sopletes a manguera / Hose connection torches



No.		P00408900	253250100	P00508900	253250200	253031600	P00109200
Soldadura fuerte / Brazing		hasta / up to 22 mm Ø		hasta / up to 22 mm Ø			hasta / up to 28 mm Ø
Soldadura blanda / Soft soldering		hasta / up to 54 mm Ø		hasta / up to 54 mm Ø			hasta / up to 54 mm Ø
Boquilla / Burner		19 mm Ø M14x1		22 mm Ø M14x1			18 mm Ø M14x1
Mango Handle	Regulador llama / Flame regulator	NO		SI / YES			SI / YES
	Regulador gas / Propane regulator	SI / YES		SI / YES			SI / YES
	Gatillo economizador / Operating trigger	NO		SI / YES			SI / YES
Manguera / Hose	Entrada / In	W21,8"L	R3/8"L	R3/8"L	R3/8"L	Conexión espiga / Nipple trigger	W21,8"L
	Salida / Out	R3/8"L	R3/8"L	W21,8"	W21,8"		R3/8"L
	Longitud / Length	2 m.	2,5 m.	2 m.	2,5 m.	8 m.	2 m.

Página 105 105 105 105 106

Sopletes a manguera con conexión de espiga / Handles with nipple connection hose



No.		253030300	1000000538	253030200	253031100	253031200
Quemador / Burner	Estandar / Standard	35 mm Ø		28 mm Ø		
	Calentamiento / Heating up				63 mm Ø	
	Antiviento / Windproof		63 mm Ø			57 mm Ø
Lanza / Extension		200 mm	600 mm	100 mm	600 mm	600 mm
Mango / Handle	Regulador gas / Propane regulator	SI / YES	SI / YES	SI / YES	SI / YES	SI / YES
	Regulador llama / Flame regulator	NO	NO	SI / YES	SI / YES	SI / YES
	Gatillo / Trigger	NO	NO	SI / YES	SI / YES	SI / YES
	Conexión / Connection	Conexión espiga / Nipple trigger				
Manguera / Hose						

Página 107 107 107 107 107

Sopletes línea SEGOFLAME

Para aplicaciones en trabajos de fontanería, decapado, calentamiento y aplicaciones domésticas.

Prácticos y manejables, están diseñados para el uso con cartuchos perforables y desechables que quedan cubiertos con una carcasa de plástico reforzada con fibra de vidrio.

Disponibles con o sin encendido PIEZO.

SEGOFLAME torches line

For plumbing, descaling, heating and domestic applications.

Practical and easy use, for use with disposable dunch in cartridges covered with glass fiber reinforced plastic housing.

Two models: without or with PIEZO ignition.

DATOS TECNICOS / TECHNICAL DATA

Aplicación / Application:

Soldadura blanda / Soft soldering Ø 16 mm

Quemador / Burner: Ø 22 mm

Conexión / Connection:

Cartucho perforable / Pluggable cartridge

Encendido PIEZO / PIEZO ignition:

SEGOFLAME NO

SEGOFLAME PIEZO SI / YES

Regulador llama / Regulating valve: SI / YES



Quemador intercambiable en acero inox de 22 mm Ø.

Exchangeable Stainless steel 22 mm Ø burner.

Botón PIEZO y regulador de llama.

PIEZO ignition and flame regulator.

Mango estable y ergonómico.

Stable and ergonomic handle.

Regulador de llama.

Flame regulator.

SEGOFLAME PIEZO
No. 3593100



Funciona en posición invertida con calentamiento previo.

It works in inverted position without pre-heating.



SEGOFLAME
No. 3593000

Made in Spain

Presentación / Product display



No. 3593000

No. 3593100

No. P00591000

No.			
3593000	SEGOFLAME	•	1
P00591000	SEGOFLAME + 3 BTP C200	•	1
3593100	SEGOFLAME PIEZO		
Quemadores / Burneres			
223431400	Para / For SEGOFLAME		1
35561	Para / For SEGOFLAME PIEZO	•	1
Cartuchos desechables / Cartuchos descartáveis			
SEH020500	BTP C200		36

Sopletes línea SEGOFIRE

Para aplicaciones en trabajos de fontanería, decapado, calentamiento y aplicaciones domésticas.

Prácticos y manejables, están diseñados para el uso con cartuchos desechables con conexión a rosca EU 7/16"

Disponibles con o sin encendido PIEZO.

DATOS TECNICOS / TECHNICAL DATA

Aplicación / Application:

Soldadura fuerte / Brazing \varnothing 16 mm

Soldadura blanda / Soft soldering \varnothing 22 mm

Quemador / Burner: \varnothing 22 mm

Conexión / Connection: EU 7/16"

Encendido PIEZO / PIEZO ignition:

SEGOFIRE NO

SEGOFIRE PIEZO SI / YES

Regulador llama / Regulating valve: SI / YES

Sopletes

For plumbing, descaling, heating and domestic applications. Practical and easy use, for use with disposable cartridge with connection EU 7/16".

Two models: without or with PIEZO ignition.

Botón PIEZO y regulador de llama.

PIEZO ignition and flame regulator.



SEGOFIRE PIEZO + BTP 300
No. 3555500



Funciona en posición invertida con calentamiento previo.

It works in inverted position without pre-heating.





Regulador de llama.

Flame regulator.

SEGOFIRE



No.			
3550100	SEGOFIRE + BTP 300	•	1
3555500	SEGOFIRE PIEZO + BTP 300	•	1
P00555500	SEGOFIRE PIEZO + 3 BTP 300	•	
254200000	SEGOFIRE PIEZO (Bulk)		1
Accesorios / Accessories			
223432200	Quemador para / Burner for SEGOFIRE		1
35561	Quemador para / Burner for SEGOFIRE PIEZO		1
SEH020300	Cartucho desechable / Cartucho descartável BTP C200		24
254202300	Anillo goma (exterior) / Rubber ring (outside)		1
254201100	Junta tórica (interior) / O-ring (inside)		1

Presentación / Product display

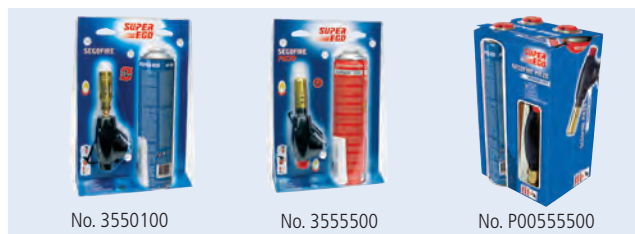

No. 3550100

No. 3555500

No. P00555500

Soplete EASY-FIRE

Soplete piezoeléctrico para aplicaciones de fontanería profesional, aircon y de soldadura de joyería. Soldadura blanda, soldadura fuerte y termocontracción.

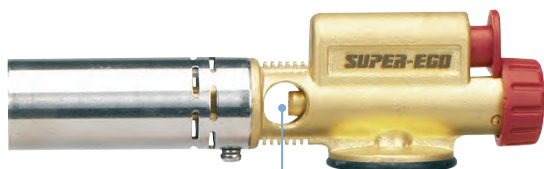

Presentación / Product display



No. R3555300

Sistema de refrigeración
Cooling system



MULTIFIRE torch

Piezoelectric torch for professional Plumbing, Aircon, jewellery soldering applications. Soft soldering, brazing and heat shrinking.

DATOS TECNICOS / TECHNICAL DATA

Aplicación / Application:	
Soldadura fuerte / Brazing	Ø 15 mm
Soldadura blanda / Soft soldering	Ø 22 mm
Quemador / Burner:	Ø 22 mm
Conexión / Connection:	EU 7/16"
Encendido PIEZO / PIEZO ignition:	SI / YES
Regulador llama / Regulating valve:	SI / YES

No.			
R3555300	EASY-FIRE	•	1
Accesorios / Accessories			
SEH020300	Cartucho desechable / Disposable cartridge BTP 300		24

Soplete MULTIFIRE

Soplete multiusos piezoeléctrico para usos culinarios (flampear, caramelizar, tostar, dar color y textura a la comida y mejorar la presentación de platos), encendido de barbacoas y fuegos bajos, descongelar tuberías y trabajos manuales y modelismo.



Presentación / Product display



No. SEH024700

No. 1000000419

MULTIFIRE torch

All purpose piezoelectric torch for culinary uses (caramelising, toasting, colouring and texturing and improving dish presentation), lighting barbecues and low fires, defrosting pipes and and work and model making.

DATOS TECNICOS / TECHNICAL DATA

Quemador / Burner:	Ø 22 mm
Encendido PIEZO / PIEZO ignition:	SI / YES
Regulador llama / Regulating valve:	SI / YES

Funciona en posición invertida sin calentamiento previo.
It works in inverted position without pre-heating.



No.			
SEH024700	MULTIFIRE	•	1
1000000419	MULTIFIRE + 2 cartuchos / cartridges BTN 250	•	1
Accesorios / Accessories			
SEH003800	Cartucho desechable / Disposable cartridge BTN 250		28

Soplete SUPER-FOGO

Para aplicaciones profesionales de fontanería, aircon y soldadura de joyería.

Llamo tipo dardo.



Torch SUPER-FOGO

For professional Plumbing, Aircon, jewellery soldering applications.

Sharp flame.

DATOS TECNICOS / TECHNICAL DATA

Aplicación / Application:	
Soldadura fuerte / Brazing	Ø 22 mm
Soldadura blanda / Soft soldering	Ø 28 mm
Quemador / Burner:	Ø 16 mm
Conexión / Connection:	US 1"
Regulador llama / Regulating valve:	SI / YES

No.			
254400000	SUPER-FOGO	•	1
Accesorios / Accessories			
SEH024600	Cartucho desechable / Disposable cartridge US1"		12
263003400	Adaptador para botella / Adapter for cartridge EU 7/16"		1

POWER-FIRE COMPACT

Soplete piezoeléctrico profesional para soldadura fuerte de tuberías de cobre hasta Ø 28 mm con alto contenido de plata en las varillas de soldar. Recomendado para todo tipo de soldadura blanda y fuerte.

POWER-FIRE COMPACT

Piezoignition professional for brazing copper pipes up to 35 mm Ø with high silver content rods. Recommended for all types of soft and hard soldering.

DATOS TECNICOS / TECHNICAL DATA

Aplicación / Application:	Tuberías / Pipes Cu
Soldadura fuerte / Brazing	Ø 28 mm
Soldadura blanda / Soft soldering	Ø 35 mm
Quemador / Burner:	Ø 16 mm
Conexión / Connection:	US 1"
Encendido PIEZO / PIEZO ignition:	SI / YES
Regulador llama / Regulating valve:	SI / YES



Llama envolvente
Cyclone burner



Quemador en acero
inox de 16 mm Ø
Stainless steel 16 mm
Ø burner.

Efecto Venturi para una
mezcla óptima de gas/aire.

Venturi for optimum air fuel
mixture.

Botón PIEZO y regulador
de llama

PIEZO ignition and
flame regulator

Presentación / Product display



No. 254800100



360°

US 1"
No. 254800000

Adaptador / adaptor
No. 263003400

EU 7/16"

Funciona en posición invertida sin
calentamiento previo.
It works in inverted position without
pre-heating.

Adaptador (No. 263003400) necesario
para uso con botella EU 7/16".
Necessary adaptor (No. 263003400)
for use with EU 7/16" cartridges.

Made in Spain

No.

No.			
254800000	POWER-FIRE COMPACT US 1"	•	1
254800100	POWER-FIRE COMPACT US 1" + Cartridges	•	1
SEH024600	Cartucho desechable / Disposable cartridge US1"		12
263003400	Adaptador para botella / Adapter for cartridge EU 7/16"		1
35561	Quemador / Burner Ø 22 mm	•	1

ROMASSGAS

Con válvula de seguridad. Se puede conectar y desconectar fácilmente. Mezcla estabilizada de gas metil-acetileno con propadieno. 35% más rápido que el propano.

With safety valve. Easy connect - disconnect. Stabilized mixture of methyl-acetylene and propadiene. 35% quicker than propane.

DATOS TECNICOS / TECHNICAL DATA

Conexión / Connection: **US 1"**
 Temperatura / Temperature: **2.600 °C**



No.



SEH024600 | ROMASSGAS | 12

Gas BTP 300

Con válvula de seguridad. Se puede conectar y desconectar fácilmente. Contiene combinación 35% propano y 65% butano.

With safety valve. Easy connect - disconnect. Contains mixture of 35% propane and 65% butane.

DATOS TECNICOS / TECHNICAL DATA

Conexión / Connection: **EU 7/16"**
 Temperatura / Temperature: **1.925 °C**

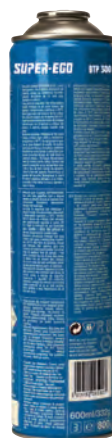

No.



SEH020300 | Gas BTP 300 | 24

BTP C200

Cartucho desechable perforable. Contiene combinación de propano y butano. Dispone de válvula de seguridad.

Disposable dunch in cartridge. Contains mixture of propane and butane. Dispone de válvula de seguridad.

DATOS TECNICOS / TECHNICAL DATA

Conexión / Connection: **Perforable/Dunch in**
 Temperatura / Temperature: **1.925 °C**



No.



1500001065 | BTP C200 | 36

BTN 250

Con válvula de seguridad. Se puede conectar y desconectar fácilmente. Contiene 100% gas butano.

With safety valve. Easy connect - disconnect. Contains 100% gas butane.

DATOS TECNICOS / TECHNICAL DATA

Conexión / Connection: **Universal / Universal**
 Temperatura / Temperature: **1.925 °C**



No.



SEH003800 | BTN 250 | 28

WARNING: Do NOT remove the cartridge after being punched in.

ATENCION: Una vez perforado el cartucho NO desenroscar.

ATTENTION: Une fois la cartouche perforée, NE pas dévisser.

Sopletes a manguera

Sopletes de alto rendimiento a butano-propano para aplicaciones profesionales de fontanería, aircon y pelado o decapado. Soldadura blanda y dura y trabajo por calentamiento.

AIRPROP®

Compuesto por: boquilla roscada AIRPROP® Ø 19 mm, mango ergonómico con regulador de gas, manguera de alta presión con conexión roscada al depósito de gas.

DATOS TECNICOS / TECHNICAL DATA

Aplicación / Application:

Soldadura fuerte / Brazing	Ø 22 mm
Soldadura blanda / Soft soldering	Ø 54 mm
Boquilla / Burner:	Ø 19 mm M14x1

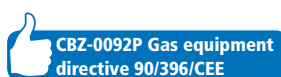

No.	Manguera / Hose		L	•	1
	Entrada / In	Salida / Out			
P00408900	W21,8"L	R3/8"L	2 m.	•	1
253250100	R3/8"L	R3/8"L	2,5 m.	•	1

Hose connection torches

Butane-propane high-performance torches for plumbing, Aircon and stripping or descaling applications. Soft soldering and bracing and heating applications.

AIRPROP®

Include: threaded burner AIRPROP® Ø 19 mm, ergonomic handle with gas regulator, high pressure hose gas 2 m. with connections R3/8"L.



AIRPROP® PLUS

Compuesto por: boquilla roscada AIRPROP® Ø 22 mm, mango ergonómico con regulador de llama piloto, regulador de gas y gatillo economizador, 2 m. de manguera de alta presión con conexión roscada R3/8" al depósito de gas.

DATOS TECNICOS / TECHNICAL DATA

Aplicación / Application:

Soldadura fuerte / Brazing	Ø 22 mm
Soldadura blanda / Soft soldering	Ø 54 mm
Boquilla / Burner:	Ø 22 mm M14x1

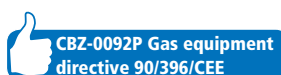

No.	Manguera / Hose		L	•	1
	Entrada / In	Salida / Out			
P00508900	R3/8"L	W21,8"	2 m.	•	1
253250200	R3/8"L	W21,8"	2,5 m.	•	1
253031600	Conexión espiga / Nipple trigger		8 m.	•	1

AIRPROP® PLUS

Include: threaded burner AIRPROP® Ø 22 mm, ergonomic handle with pilot flame regulator, gas regulator and ergonomic trigger, high pressure hose gas 2 m. with connections R3/8"L.



TURBOPROP®

Compuesto por: boquilla roscada efecto venturi TURBOPROP® Ø 18 mm, mango ergonómico con regulador de llama piloto, regulador de gas y gatillo economizador, 2 m. manguera de alta presión con conexión roscada al depósito de gas.

DATOS TECNICOS / TECHNICAL DATA

Aplicación / Application:

Soldadura fuerte / Brazing	Ø 28 mm
Soldadura blanda / Soft soldering	Ø 54 mm
Boquilla / Burner:	Ø 18 mm M14x1

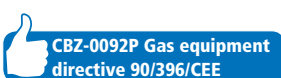

No.	Manguera / Hose		L	•	1
	Entrada / In	Salida / Out			
P00109200	W21,8"L	R3/8"L	2 m.	•	1

TURBOROP®

Include: threaded venturi effect burner TURBOPROP® Ø 18 mm, ergonomic handle with pilot flame regulator, gas regulator and ergonomic trigger, high pressure hose gas 2 m. with connections R3/8"L.

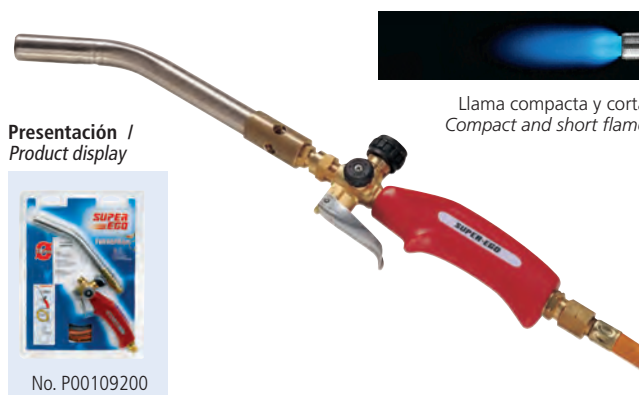

Sopletes para calentamiento

Sopletes a propano para calentamiento de superficies con boquillas de alto rendimiento hasta Ø 63 mm. Para trabajos en cubiertas y asfalto, adhesión de tela asfáltica, quemar hierbas, descongelar, aislamientos, retractilado, secado y calentamiento.

Roofing torches



Propane surface-heating torches with high efficiency burners up to Ø 63 mm. For roof work and asphalt paving, roofing felt bonding, weed burning, defreezing, insulating, shrink wrapping, drying and heating.

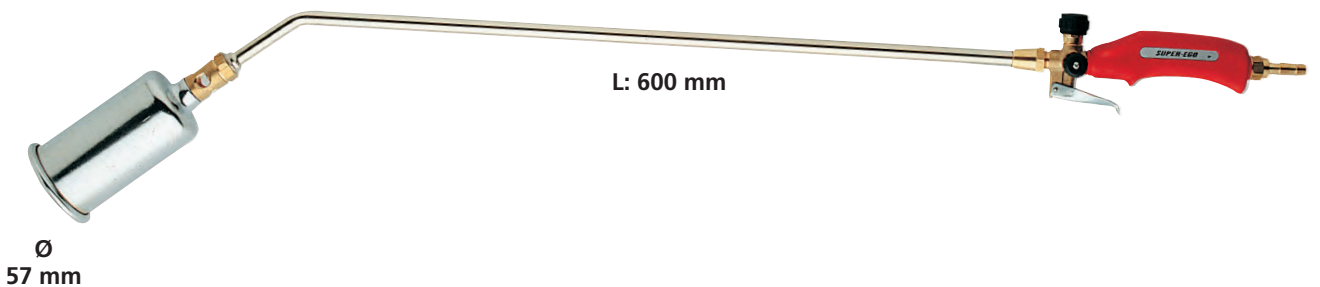
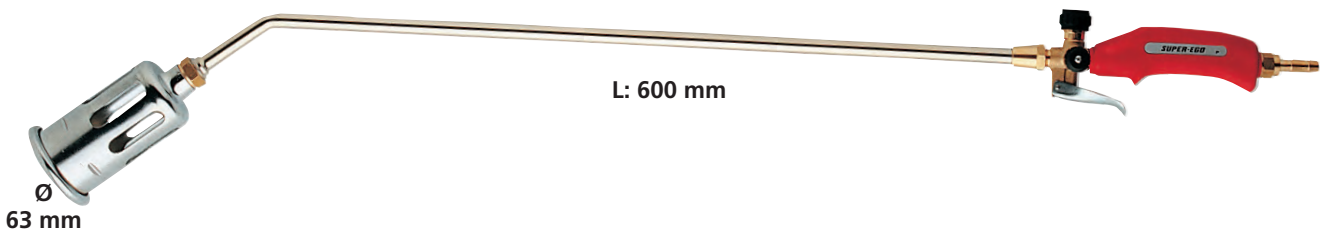
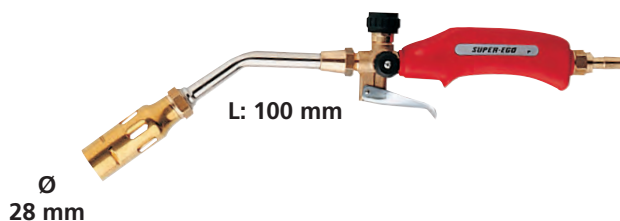
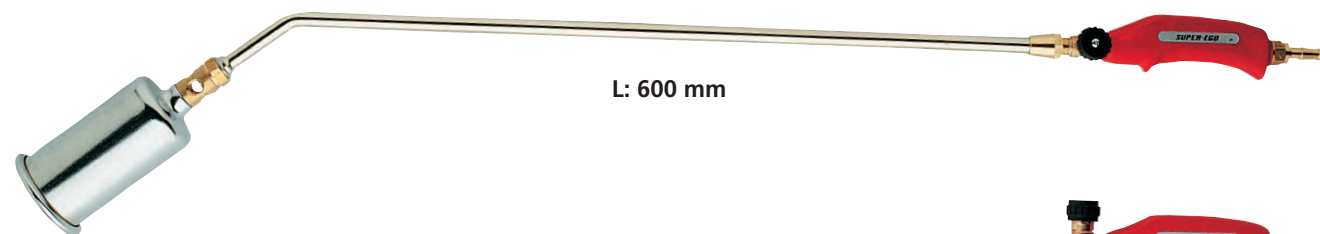
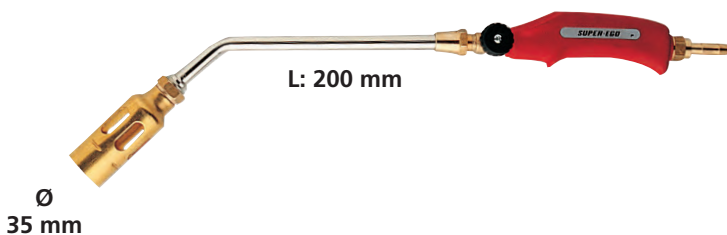

Conexión de espiga.
Nipple connection.



Made in Spain

No.	Ø Quemador / Burner			Lanza Extension ←L→	Mango / Handle			Conexión Hose coupling	Manguera Hose	 
	Estándar Standard	Calentamiento Heating up	Antiviento Windproof		Regulador gas Gas regulator	Regulador llama piloto Flame regulator	Gatillo Trigger			
253030300	35 mm			200 mm	•			•	m	• 1
100000538			63 mm	600 mm	•			•	m	• 1
253030200	28 mm			100 mm	•	•	•	•	m	• 1
253031100		63 mm		600 mm	•	•	•	•	m	• 1
253031200			57 mm	600mm	•	•	•	•	m	• 1

Quemadores estándar

Latón con tratamiento de superficie.
Estabilizador, potencia constante, bajo consumo energético.
Potente llama.
Conexión: M20x1.



Standard burners

Surface treated brass.
Stabilizer, constant power, low energy consumption.
Powerful flame.
Connection: M20x1.



Made in Spain

No.	Ø mm	L mm	g/h 2bar	kWH-kcal-BTU	g.		
223012200	22	68	300	3,84 - 3300 - 13115	65	•	1
223012800	28	73	450	5,76 - 4950 - 19670	80	•	1
223013200	32	80	700	8,95 - 7700 - 30565	110	•	1
223013500	35	88	1600	20,50 - 17600 - 70010	130	•	1

Quemadores de calentamiento

Para recubrimientos asfálticos de tejados, envolturas retráctiles, trabajos de aislamiento y reparaciones generales que necesiten calor.
Acero especial al cromo, labio reforzado con estabilizador de llama.
Conexión: M20x1.



Standard burners

For tar roofing applications, shrink wrapping, insulation work and general heat demanding repairs.
Special chrome alloy steel, reinforced flange with flame stabilizer.
Connection: M20x1.



Made in Spain

No.	Ø mm	L mm	g/h 2bar	kWH-kcal-BTU	g.		
223014500	45	102	2500	32,00 - 27500 - 109280	215	•	1
223015100	51	112	3800	48,60 - 41800 - 165970	270	•	1
223015700	57	126	5500	70,35 - 60500 - 240250	350	•	1
223016300	63	138	6700	85,70 - 73700 - 292670	440	•	1

Quemadores calentamiento antiviento

Muy efectivo, en especial en trabajos exteriores de recubrimiento de tejados que necesiten juntas y bordes soldados.
El cuerpo cerrado y la succión de aire-oxígeno por la parte posterior proporcionan una llama larga de mucha presión a la que no afectan los vientos fuertes. Acero especial al cromo, labio reforzado.
Conexión: M20x1.



Heating up burn windproof

Very effective, specially for outside tar roofing work requiring heat welded joints and edges.
The closed body and bottom air-oxygen intake provide a long and high pressure flame unaffected by strong winds. Special chrome alloy steel, reinforced flange. Connection: M20x1.



Made in Spain

No.	Ø mm	L mm	g/h 2bar	kWH-kcal-BTU	g.		
223213500	35	115	1400	17,91 - 15399 - 61111	162	•	1
223214500	45	125	2500	32,00 - 27500 - 109280	240	•	1
223215100	51	135	3800	44,80 - 38500 - 153000	290	•	1
223215700	57	149	4800	61,40 - 52800 - 209690	365	•	1
223216300	63	161	7500	95,00 - 82500	475	•	1

Lanzas

Tubos de calidad especial, cromados.
Conexión: M20x1.

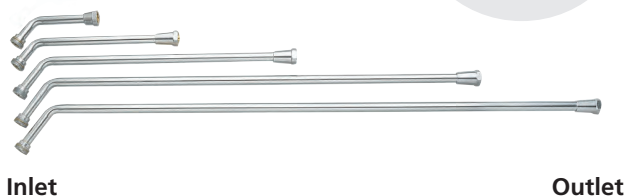
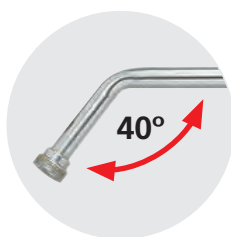

Inlet

Outlet

Extensions

Special quality chrome plated tubes.
Connection: M20x1.

Made in Spain

No.	L mm	inlet	outlet	g.		
231010000	100	M 14x1	M 20x1	90	•	1
232010000	200	M 14x1	M 20x1	130	•	1
233510000	350	M 14x1	M 20x1	200	•	1
236010000	600	M 14x1	M 20x1	300	•	1

Boquillas AIRPROP® para soldadura blanda y fuerte

Para trabajos de calentamiento, recocido y templado de metales. Ideal para la soldadura blanda y fuerte de tuberías de mayor diámetro. Llama compacta. Conexión: M14x1.



Soft soldering and brazing burners AIRPROP®

It works in metal heating, annealing and hardening. Soft and hard soldering on bigger diameter tubes. Compact flame. Connection: M14x1

Made in Spain

No.	Ø mm	g/h 2bar	KWH-kcal-BTU	g.		
22111900	19	300	3,84 - 3300 - 13115	130	•	1
22112200	22	400	5,12 - 4400 - 26195	145	•	1

Boquillas TURBOPROP® para soldadura blanda y fuerte

Llama compacta muy corta. Acero inoxidable y latón. Bajo consumo de gas. Efecto venturi. Conexión: M14x1.



Soft soldering and brazing burners TURBOPROP®

Compact very short flame. Stainless steel and brass. Low gas consumption. Venturi effect. Connection: M14x1

Made in Spain

No.	Ø mm	g/h 2bar	KWH-kcal-BTU	g.		
221011000	10	70	0,89 - 770 - 3055	90	•	1
221011200	12	110	1,41 - 1210 - 4815	95	•	1
221011500	15	180	2,30 - 1980 - 7855	100	•	1
221011800	18	240	3,07 - 2640 - 10485	130	•	1
221012400	24	450	5,75 - 4950 - 19640	145	•	1

Boquillas envolventes

Llama compacta que envuelve la tubería asegurando un calentamiento uniforme de toda la superficie. Con conexión roscada.



Enveloping flame burners

Compact flame envelops the pipe ensuring uniform surface heating. Threaded connection.

Made in Spain

No.	Ø mm	g/h 2bar	g.		
221412200	22	140	90	•	1
221413500	35	255	95	•	1

Mangos M 14x1



Made in Spain

No.	Regulador gas Gas regulator	Regulador llama piloto Flame regulator	Gatillo Trigger	Conexión a manguera Hose connection		
212111100	•			R 3/8" L	•	1
212114100	•			Conexión espiga / Nipple	•	1
211111100	•	•	•	R 3/8" L	•	1
211114100	•	•	•	Conexión espiga / Nipple	•	1
211115300	•	•	• (largo / long)	R 3/8" L	•	1

Manguera de alta presión



Made in Spain

No.	L mm	inlet	outlet	g.		
Butano/propano / Butane/propane						
251232200	2,5	R 3/8" L	R 3/8" L	350	•	1
100000946	2	W21,8L	R 3/8" L	300	•	1
251266200	3	W21,8L	R 3/8" L	700	•	1
Acetileno / Acetylene						
251322200	2	R 3/8" L	R 3/8" L	300	•	1
Accesorios / Accessories						
240140000	Tuerca hexagonal / Hexagonal nut R 3/8" L			20	•	1
990100100	Espiga / Nipple for hose - Ø int. 6,3 mm			70	•	1
210013000	Espiga / Nipple for hose - Ø int. 8 mm			70	•	1

High pressure hose

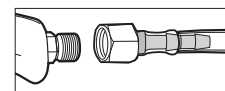

Soporte para soplete

Se acopla fácilmente a las boquillas y lanzas. Las boquillas calientes se pueden dejar reposar de forma segura.

Made in Spain

No.		
252010000	Soporte para soplete / Torch support	• 1

Torch support

Easily coupled to burners and lances. Hot burners can be safely left on supports.

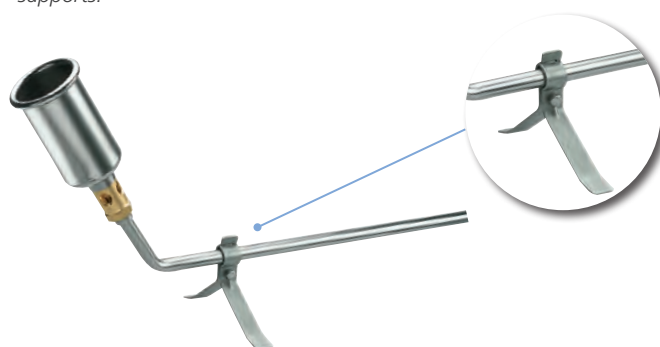

Soporte para brazo

Se acopla al mango con gatillo largo y conexión para soporte de brazo.

Made in Spain

No.		
252011100	Soporte para brazo / Arm support	• 1

Arm support

Cupled to the handle with long trigger and arm support connection.

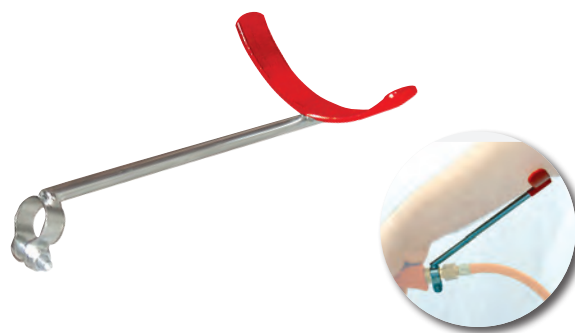

Válvulas reguladoras de presión para propano

Fabricadas en latón.
Regulable de 0 a 6 bar.
Entrada W21,8L x 1.1/4" C y salida R 3/8" L.

Made in Spain

No.		
242206000	R 3/8" L - 10 kg/h.	• 1
242203000	POL 7/8" L metallic gasket - 10 kg/h.	• 1

Propane pressure regulator

Made out of brass.
Adjustable from 0 to 6 bar.
W21,8L inlet x 1.1/4" C and R 3/8" L outlet.



No. 242206000



No. 242203000

Polifusor electrónico

Polifusor electrónico con regulación de temperatura para tuberías y accesorios de plástico diseñado para soldar tuberías y accesorios de PE, PP, PB y PVDF, tanto en taller como en obra.

Socket welder

Socket welder electronic with temperature regulation for plastic tubes and accessories designed for welding PE, PP, PB and PVDF tubes and accessories whether at the shop or the job-site.

DATOS TECNICOS / TECHNICAL DATA	
Aplicación / Application:	PE, PP, PB y PVDF,
Capacidad / Capacity:	max. Ø 110 mm
Voltaje / Voltage:	110V / 50-60 Hz 230V / 50-60 Hz
Potencia / Power:	800 W / 1.000W

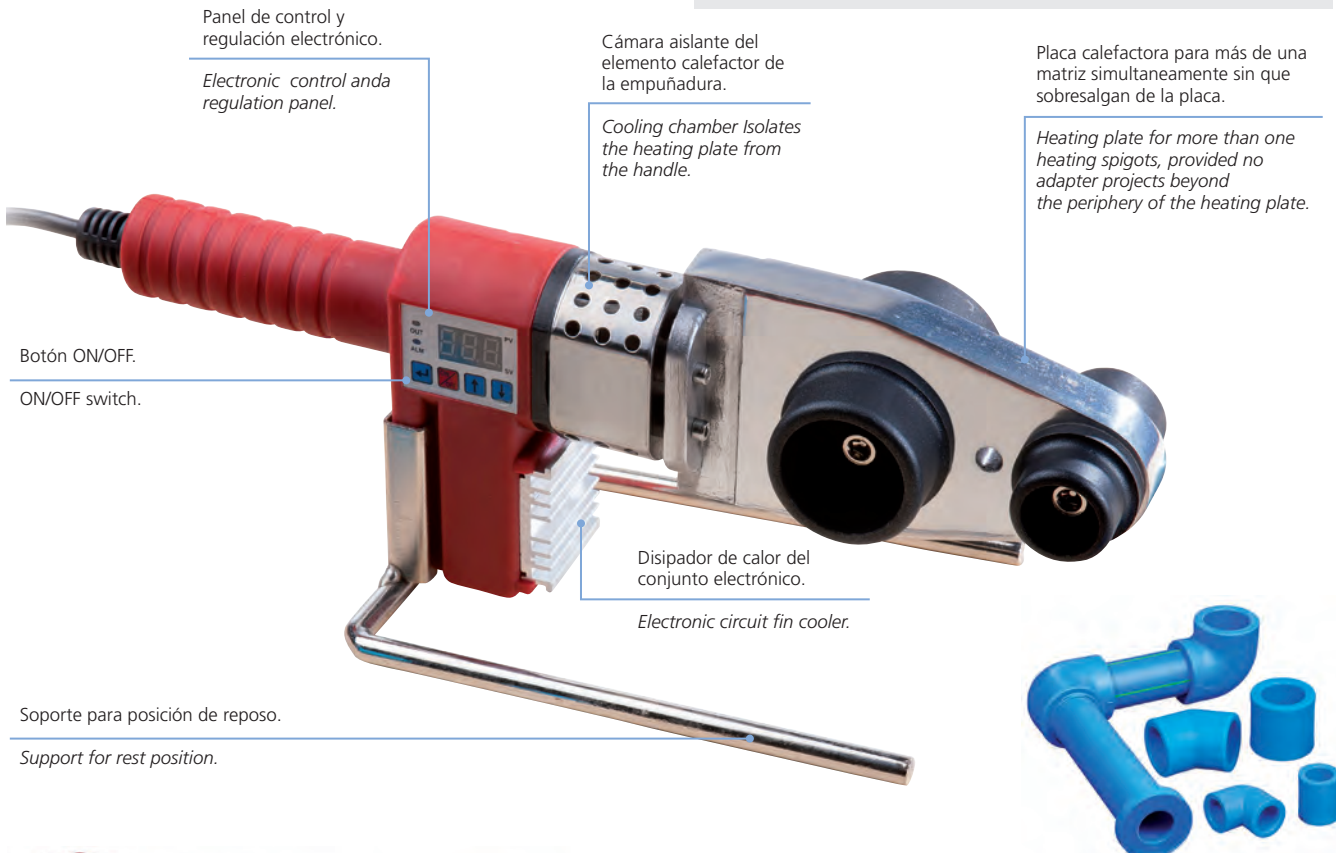

Los conjuntos incluyen: polifusor, matrices, soporte y llave Allen en maleta metálica para su transporte y almacenaje.
The sets included: socket welder, adapters, support and Allen wrench in a metal carrying and storage case.

No.	Composición / composition		
1500000447	20, 25 y 32 mm Ø	230 V	1
1500000448	20, 25, 32, 40, 50 y 63 mm Ø	230 V	1
1500000449	75, 90 y 110 mm Ø	230 V	1
1500001716	20, 25 y 32 mm Ø	110 V	1
Matrices / Heating spigots			
1500000687	20 mm		1
1500000688	25 mm		1
1500000689	32 mm		1
1500000690	40 mm		1
1500000713	50 mm		1
1500000691	63 mm		1
1500000692	75 mm		1
1500000693	90 mm		1
1500000694	110 mm		1



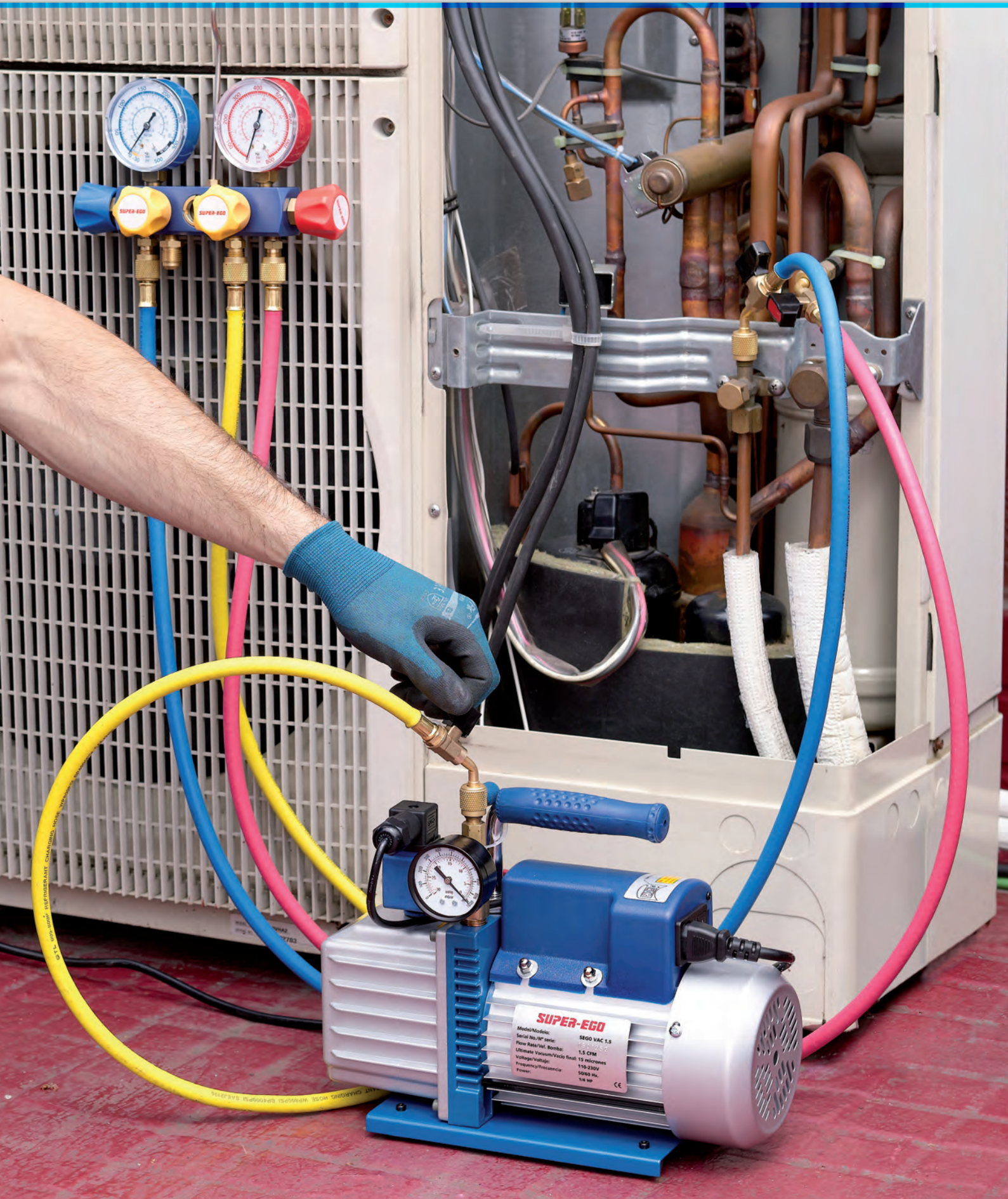

Equipos y herramientas para HVAC&R

Bombas de vacío	114
Unidad de recuperación de refrigerante	115
Manómetros analógicos	116
Mangueras	116
Báscula	117
Abocinador	117
Detector	118
Termómetro digital	118

HVAC&R service tool

<i>Vacuum pumps</i>	114
<i>Refrigerant recovery device</i>	115
<i>Analogue manifolds</i>	116
<i>Hoses</i>	116
<i>Scale</i>	117
<i>Flaring tool</i>	117
<i>Detector</i>	118
<i>Digital-Thermometer</i>	118



Bombas de vacío / Vacuum pumps

SEGO VAC

Bomba de vacío de 2 tiempos con vacuómetro y válvula selenoide antirretorno para evitar el reflujo del aceite al sistema.

SEGO VAC

Two-stage vacuum pump with vacuum gauge and non-return selenoide valve to protect the system from oil contamination during power outage.

Vacuómetro Ø 54 mm, para un control del proceso de evacuación sencillo y rápido.

Vacuum gauge Ø 54 mm, for a simple and fast control of the evacuation process.

Mango ergonómico con protección para un agarre más cómodo.

Ergonomic handle with protection, for a more comfortable grip.



Carga de aceite de fácil acceso.

Easy access oil charge.

Visor con indicador de nivel de aceite y sistema de drenaje de aceite para un vaciado sencillo.

Optimal positioned viewing glass and oil drains for simple draining of the oil.



Nuevas bombas para el uso con refrigerante R32.

New pumps to use with R32 refrigerant.

Carcasa y cubierta del ventilador fabricadas en aluminio fundido.

Casing and fan protection made in cast aluminum.

Base robusta para una mayor estabilidad.

Robust base for a great stability.



SEGO VAC 6.0
No.1500001501



Incluye: adaptadores (5/16"SAE y 3/8"SAE) y botella de plástico de aceite mineral (250 ml.).

Included: adaptors (5/16"SAE y 3/8"SAE) and mineral oil plastic bottle (250 ml.).

4

		SEGO VAC 1.5 1500001398		SEGO VAC 1.5 R32 1500002662		SEGO VAC 3.0 1500001399		SEGO VAC 3.0 R32 1500002663		SEGO VAC 6.0 1500001501	
Voltaje	Voltage	220V-50 Hz	110V-60 Hz	230V-50 Hz	230V-60 Hz	220V-50 Hz	110V-60 Hz	230V-50 Hz	230V-60 Hz	220V-50 Hz	110V-60 Hz
Caudal	Flow rate	1.5 CFM 42 l/min	1.8 CFM 50 l/min	1.5 CFM 42 l/min	1.8 CFM 50 l/min	2.5 CFM 70 l/min	3.0 CFM 84 l/min	2.5 CFM 70 l/min	3.0 CFM 84 l/min	6.0 CFM 170 l/min	7.0 CFM 198 l/min
Etapas	Stages	2		2		2		2		2	
Vacío	Ultimate Vacuum	15 micron		15 micron		15 micron		15 micron		15 micron	
Potencia	Power	1/4 HP		1/4 HP		1/4 HP		1/4 HP		3/4 HP	
Conexión	Inlet port	1/4"		1/4"		1/4"		1/4"		1/4"	
Capacidad de aceite	Oil Capacity	310 ml		310 ml		310 ml		310 ml		580 ml	
Dimensiones	Dimensions	285 x 124 x 230 mm		285 x 124 x 230 mm		285 x 124 x 230 mm		285 x 124 x 230 mm		295 x 145 x 297 mm	
Peso	Weight	6,3 Kg.		6,3 Kg.		7,1 Kg.		7,1 Kg.		7,4 Kg.	
		1		1		1		1		1	

SEGO REC V

Unidad de recuperación de refrigerante. Dispositivo compacto y portátil para la recuperación de refrigerantes de todo tipo

Compresor sin aceite, funcionamiento sin mantenimiento.

Función de PURGA, vaciado de refrigerante residual de la unidad (modo autolimpieza).

Cable desmontable, evita posibles daños.

Equipado con cinta ajustable para el hombro.

SEGO REC V

Refrigerant recovery device. Compact, portable device for recovery refrigerants of all kinds

Oil-free compressor, maintenance-free operation.

PURGE function, emptying of refrigerant residue in the unit (self-cleaning mode).

Removable wire, prevents wire damage.

Equipped with adjustable shoulder strap.

Refrigerantes / Refrigerants:

Categoría / Category III: R12, R134A, R401C, R500

Categoría / Category IV: R22, R401A, R401B, R402B, R407C, R407D, R408A, R409A, R411A, R411B, R412A, R502, R509

Categoría / Category IV: R402A, R404A, R407A, R407B, R410A, R507



SEGO REC V
No. 1500001400

3 funciones: Apertura-cierre /
Entrada-salida / Purga-recuperación.

3 functions:
Opening-closing / In-out / Purge-recovery.



Nueva unidad de recuperación para el uso con refrigerantes R32.

New refrigerant recovery device to use with R32 refrigerants.

Unidad aire acondicionado para exteriores
Outdoor air-conditioning unit

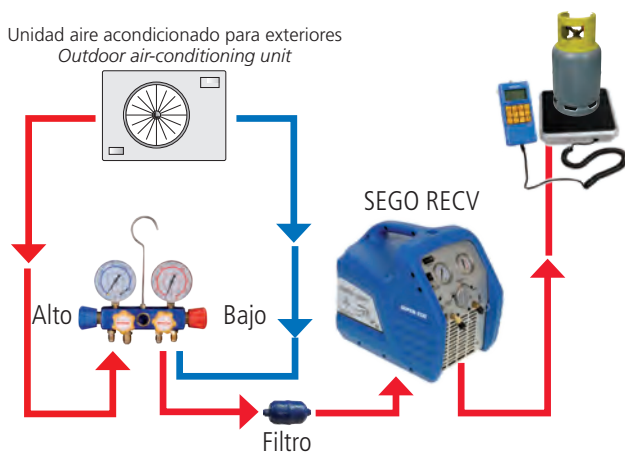

SEGO REC R32
No. 1500002664

SEGO REC V
1500001400

SEGO REC R32
1500002664



		220-240 V / 50-60 Hz	115V-60 Hz	220-240 V / 50-60 Hz
Voltaje	Voltage	220-240 V / 50-60 Hz	115V-60 Hz	220-240 V / 50-60 Hz
Potencia	Power	3/4 HP		3/4 HP
Velocidad de motor	Motor speed	1450 r.p.m. - 50 Hz 1750 r.p.m. - 60 Hz		1450 r.p.m. - 50 Hz 1750 r.p.m. - 60 Hz
Máx. consumo	Max. consumption	220-240 V / 4A	115V / 8A	4A
Conexión	Inlet port	1/4"		1/4"
Presostato	Pressure switch	38.5 bar / 3850 kPa (558 psi)		38.5 bar / 3850 kPa (558 psi)
Temperatura de funcionamiento	Operating temperature	0° - 40°C		0° - 40°C
Dimensiones	Dimensions	450 x 250 x 355 mm		450 x 250 x 355 mm
Peso	Weight	13 Kg.		13,5 Kg.
		1		1

SEGO MANFL

Manómetro analógico Ø 68 mm.
Provisto de visor refrigerante.
Escala de presiones: 0-800 psi, 30-500 psi.



Nuevo manómetro para el uso con refrigerante R32.

New manifolds to use with R32 refrigerant.

No. 1500001402

SEGO MANFL

Analogue manifolds Ø 68 mm.
With refrigerant viewer.
Pressure scales: 0-800 psi, 30-500 psi.

No.		Vías Ways	
R410A			
1500002233	SEGO MANFL - 5/16" SAE	2	1
1500001402	SEGO MANFL - 5/16" SAE	4	1
R22 R134A R407C R404A			
1500002235	SEGO MANFL - 1/4" SAE	2	1
1500001403	SEGO MANFL - 1/4" SAE	4	1
R32 R410A			
1500002665	SEGO MANFL - 5/16" SAE	4	1

SEGO HS PRO

Juego 3 mangueras de alta presión.
Uso seguro gracias al código de colores (azul-rojo-amarillo).
Dispone de válvula esférica.
Conexiones: 5/16" - 5/16".
Longitud: 1500 mm.



No. 1500001406

SEGO HS PRO

Set of 3 high strength refrigerant tubes.
Safe use with the colour coding (blue-red-yellow).
With spherical valve.
Connections: 5/16" - 5/16".
Length: 1500 mm.

No.		
R410A		
1500001406	SEGO HS PRO	1
R22 R134A R407C R404A		
1500001407	SEGO HS PRO	1

4

SEGO KIT MANFL

Kit manómetro analógico de 4 vías + juego 3 mangueras alta presión.



Nuevo kit para el uso con refrigerante R32.

New manifolds to use with R32 refrigerant.



No. 1500001405

SEGO KIT MANFL

4-way analog gauge + Set of 3 high strength refrigerant tubes

No.		
R410A		
1500001404	SEGO KIT MANFL	1
R22 R134A R407C R404A		
1500001405	SEGO KIT MANFL	1
R32 R410A		
1500002666	SEGO KIT MANFL	1

SEGO SCL

Báscula precisa para refrigerante y de fácil manejo para los procesos de llenado y evacuación con una capacidad de peso máximo de 100 kg.

Robusta, protección a los golpes.

Pantalla LCD para una correcta lectura, anti-reflejo.

Conexiones: 1/4" SAE para botellas de refrigerantes de 1 y 2 l.

Presentado en maleta de plástico para su práctico almacenaje y transporte.

DATOS TECNICOS / TECHNICAL DATA

Resolución / Resolution:	5 g.
Precisión / Accuracy:	0,05%
Peso máx. / Weight max.:	100 kg
Pantalla / Display:	LCD
Conexiones / Connections:	1/4" SAE
Dimensiones base / Base dimensions:	237 x 237 mm
Batería (incluida) / Battery (included):	DV9V
Vida de la batería / Battery life:	min. 80 horas / 80 hours
Condiciones trabajo / Working conditions:	10°C - 40°C ≥ 5%



SEGO SCL

Precise, easy to handle refrigerant scale for filling and evacuation processes with a maximal weight capacity of 100 kg.

Robust, protects against damage.

LCD display for comfortable reading, non-reflecting surface.

Connections: 1/4" SAE for connecting 1 and 2 l. refrigerant bottles.

Provided with carrying case.



No.



1500001401

SEGO SCL

1

Abocinador universal

Con anillado y remachado que garantiza un uso prolongado y una buena fiabilidad.

La empuñadura de diseño ergonómico garantiza una carga de trabajo confortable y eficiente.

La excentricidad del cono garantiza un uso prolongado de los tubos de cobre sin fracturas.

1/4", 5/16", 3/8", 1/2", 5/8", 3/4".

Universal Flaring Tool

Flaring bar with annular riveted process ensures prolong usage and reliability.

The arc transition designs of the horn aperture guarantees copper pipe prolong usage without fracturing it.

The eccentricity of the cone ensures a prolonged use of copper pipes without fracturing.

1/4", 5/16", 3/8", 1/2", 5/8", 3/4".



No.



1500001408

SEGO SCL

1

SEGO DTCTR

Detector electrónico de fugas en sistemas de refrigeración.

Sensor tipo semi-conductor, con punta duradera y gran sensibilidad, 3 g/año.

Alarmas visuales y acusticas, también función MUTE.

Función RESET.

Indicador de nivel de batería.

Indicador de fallo del sensor.



Nuevo detector para el uso con refrigerantes R32.

New leak to use with R32 refrigerants.

Sensor tipo semi-conductor, con punta duradera y gran sensibilidad, 3 g/año.

Semi-conductive sensor, durable and sensitive sensor tip, 3 g/year.

SEGO DTCTR

Electronic leak detection device for locating leaks in refrigeration systems.

Semi-conductive sensor, durable and sensitive sensor tip, 3 g/year.

Audible and visual alarms, and mute feature.

RESET feature.

Battery level indication.

Sensor failure indication.

Aplicación para refrigerantes / *Application for refrigerants:*

CFCs: R12, R11, R500, R503, etc...

HCFCs: R22, R123, R124, R502, etc...

HFCs: ex. R134a, R404a, R410A, R407C, R32 etc...

CH: R600a

DATOS TECNICOS / TECHNICAL DATA

Sonda acero flexible / <i>Flexible stainless probe</i>	40 cm.
Niveles ajustables / <i>Adjustable levels</i>	6
Pantalla / <i>Display</i>	LED
Tiempo de calentamiento / <i>Warm up time:</i>	<60 s
Tiempo de respuesta / <i>Answer time:</i>	< 3 s
Medio ambiente. / <i>Ambient environment:</i>	
Temperatura / <i>Temperature</i>	0°C 50°C;
Humedad / <i>Humidity</i>	0°C 50°C;
Temperatura / <i>Temperature</i>	< 80% sin condensación < 80% non condensing
Batería / <i>Battery</i>	3 x pilas 1,5V AA

No.



1500001409

SEGO DTCTR

1

4

SEGO TRM

Termómetro digital.

Alarma programable de temperatura. Máxima y mínima programable.

Soporte para mesa y pared.



SEGO TRM

Digital-Thermometer

Temperature alarm programmable. Minimum and Maximum programmable.

Table top stand and wall bracket.

DATOS TECNICOS / TECHNICAL DATA

Rango temperatura / <i>Temperature range:</i>	-50° a / to 300°C -58F° a / to 572F°
Precisión / <i>Accuracy:</i>	+ - (from -20° a / to 80°C) -2°F (-4°F a / to 176°F)
Resolución / <i>Resolution:</i>	0.1°C / 0.1°F
Batería / <i>Battery:</i>	1 x 1.5 V AAA
Vida de la batería / <i>Battery life:</i>	5.000 horas / hours

No.



1500001410

SEGO TRM

1

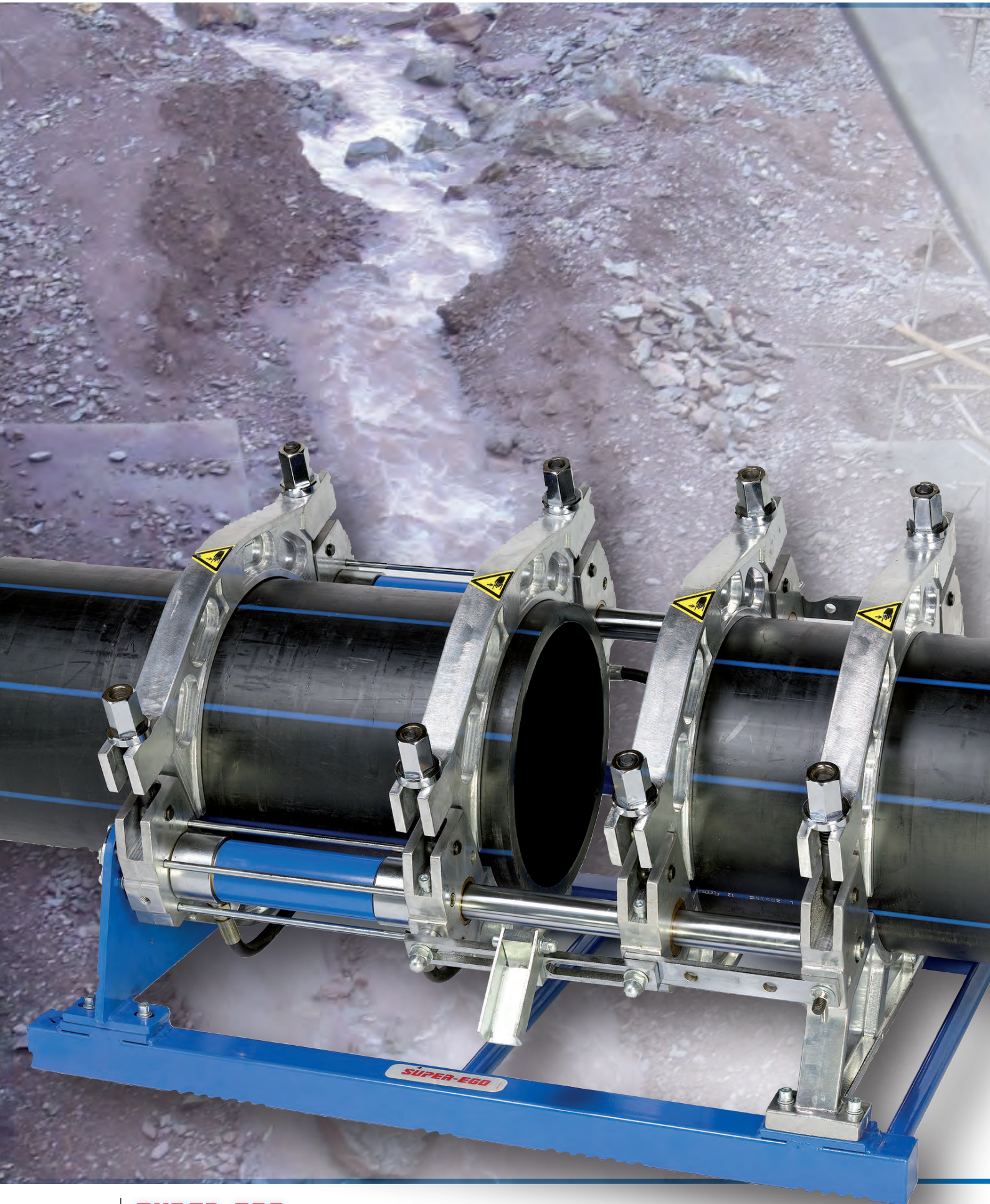

Equipos soldadura de tuberías plástico

Máquinas para soldadura a tope

122

Plastic pipe welding

Butt welding machines

122

Serie SUPER-EGO BH

Máquinas para soldadura a tope indicadas para uso en obra, zanjas o en taller.

Cumple con las normas internacionales de seguridad. Cada máquina consta de:

Refrentador

Alto par de torsión, velocidad de corte optimizada e interruptor de seguridad

Carcasa compacta cerrada de aluminio, con mecanismo de bloqueo. El diseño y montaje de las cuchillas del refrentador absorben la presión del refrentado y aseguran unos extremos paralelos al tubo. También facilitan la descarga de la viruta.

Placa calefactora

Regulación electrónica de la temperatura a través del módulo de control con interruptor de conexión/desconexión

Recubrimiento anti-adherente PTFE de gran calidad y larga vida
Ahorro de tiempo gracias al cambio rápido de la placa calefactora

Grupo hidráulico

Manómetro claro y con escala de precisión (0-100 bar, 0-10 mPa)
2 temporizadores

Bastidor que protege el grupo contra golpes en el transporte y a pie de obra.

Insertos adaptadores de mordaza

Insertos adaptadores anchos fabricados en aluminio

Máquina base

Mordazas de tubo doble para un buen agarre y una fácil alineación axial/radial del tubo

Rieles guía de acero inoxidable, los cojinetes lineales minimizan el tiro. Accionamiento de los cilindros hidráulicos a la vez

3ª mordaza desplazable libremente

SUPER-EGO BH series

Butt welding machines suitable for construction sites, trenches or in the workshop.

It complies with international safety regulations. The machines consist of:

Trimmer

High torque, optimized cutting speed and safety switch. Compact closed aluminium housing, with blocking mechanism.

Trimming tools are designed and assembled so as to absorb the milling pressure and keep the ends parallel to the pipe. This also enables easy swarf removal.

Heating plate

Electronic temperature regulation through the control module with on/off switch. High quality, long life, non-stick PTFE coating. Saves time thanks to the quick change of the heating plate

Power pack

Clear pressure gauge with precision scale (0-100 bar, 0-10 mPa).

2 timers

The frame protects the trimmer against shock during transportation and at the construction site.

Clamp adapter inserts

Wide aluminium adapter inserts

Base machine

Double tube clamps for better hold and easy axial/radial alignment of the pipe.

Stainless steel guide rails, linear bearings minimize the pull. Both hydraulic cylinders operate at the same time.

Freely moveable 3rd clamp

DATOS TECNICOS / TECHNICAL DATA

Capacidad / Operating range:	Ø 63 - 315 mm
Tipos tubos / Pipe types:	PE, PP y PVDF
Peso / Operation mode:	hidraulico / hydraulic
Presión / Pressure:	0 - 60 bars
Corriente / Current:	230V, 50Hz
Tª max. placa / Heating plate max. Tª:	270°C
Desviación de Tª / Tª deviation:	(170-250°C) < +/- 7K

Máquina base. Rígida construcción que asegura una exacta alineación

Base machine. Rigid construction for exact alignment

Placa calefactora. Regulada electrónicamente. Potencia 3000W 13,5 A

Heating plate. Electronically regulated. Power 3000W 13.5 A

Refrentador. Potencia 1100 W 8A.

Trimmer. Power 1100 W 8A.

Soporte para almacenamiento y transporte del refrentador y la placa calefactora

Support frame for trimmer storage and transport and heating plate

Insertos adaptadores de mordaza
Clamp adapter inserts

Grupo hidráulico. Sistema electro-hidráulico compacto y protegido contra la suciedad. Potencia 750 W

Hydraulic power pack
Compact electric-hydraulic system protected against dirt. Power 750 W



BH 160

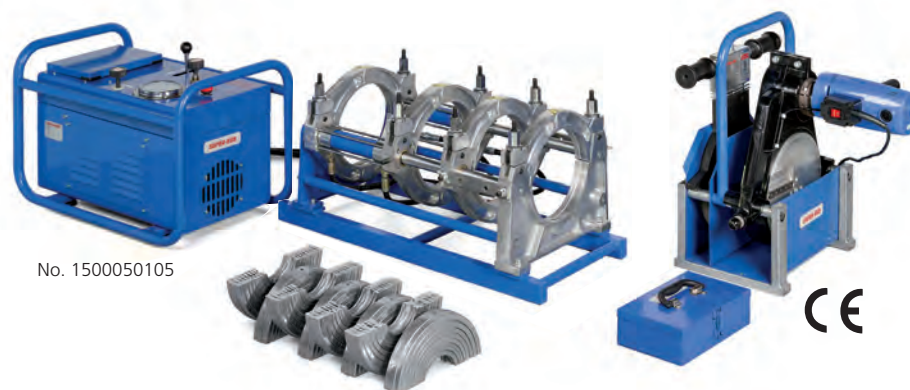

No. 1500050105

BH 250

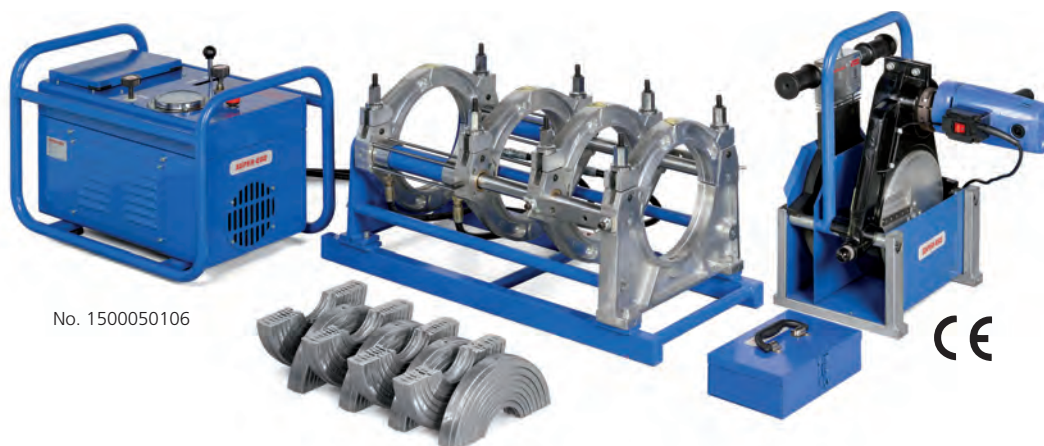

No. 1500050106

BH 315



No. 1500050107

		BH160 1500050105	BH 250 1500050106	BH 315 1500050107
Capacidad Ø mm	<i>Operating range Ø mm</i>	63, 75, 90, 110, 125, 140, 160	90, 110, 125, 140, 160, 180, 200, 225, 250	90, 110, 125, 140, 160, 180, 200, 225, 250 , 280, 315
Potencia	<i>Total power</i>	2,55 kW	3,55 kW	4,55 kW
Espesor tubo	<i>Pipe thickness</i>	Ø 160 mm SDR 7,25 (22,1 mm) Ø 63 mm SDR 33 (1,9 mm)	Ø 250 mm SDR 7,25 (34,5 mm) Ø 90 mm SDR 41 (6,1 mm)	Ø 315 mm SDR 7,25 (43,4 mm) Ø 110 mm SDR 7,4 (14,9 mm)
Potencia placa calefactora	<i>Heating plate power</i>	1,5 kW	3,0 kW	3,5 kW
Potencia refrentador	<i>Trimmer power</i>	1,1 kW	1,1 kW	1,1 kW
Potencia grupo hidráulico	<i>Hydraulic unit power</i>	0,75kW	0,75kW	0,75kW
Peso	<i>Total weight</i>	106 kg	143 kg	216 kg

No.	Página / Page	No.	Página / Page	No.	Página / Page
21062	60	101080000	13	145200000	15
21186	54	101100000	13	145300000	15
21652	45	101120000	13	170000000	81
25181	54	101140000	13	170100000	81
25182	54	101180000	13	210013000	109
25183	54	101240000	13	211111100	108
25185	54	101360000	13	211114100	108
25186	54	102080000	11	211115300	108
25190	54	102100000	11	212111100	108
25612	59	102120000	11	212114100	108
25614	59	102140000	11	221011000	108
25615	59	102180000	11	221011200	108
25616	59	102240000	11	221011500	108
25618	59	102360000	11	221011800	108
25619	59	102480000	11	221012400	108
25620	59	103300000	17	221111900	108
25622	59	103310000	17	221112200	108
25625	59	103320000	17	221412200	108
25626	59	103330000	17	221413500	108
25628	59	103340000	17	223012200	107
25652	59	103350000	17	223012800	107
25666	59	104100000	12	223013200	107
25684	59	104140000	12	223013500	107
25685	59	104180000	12	223014500	107
25743	59	104240000	12	223015100	107
25748	59	104360000	12	223015700	107
25820	59	105140000	12	223016300	107
25830	59	105140000	20	223213500	107
35561	100	105180000	12	223214500	107
35561	101	105180000	20	223215100	107
35561	103	107120000	17	223215700	107
57352	56-57	108010000	16	223216300	107
57985	56-57	108020000	16	223431400	100
57986	56-57	109010000	18	223432200	101
57987	56-57	112100000	11	231010000	107
57988	56-57	112140000	11	232010000	107
57989	56-57	117010000	18	233510000	107
57990	56-57	117480000	18	236010000	107
57991	56-57	118010000	18	240140000	109
70006	44	123010000	16	242203000	109
70041	43-44-45	123021000	16	242206000	109
70042	46	135060000	85	251232200	109
70053	47	135080000	85	251266200	109
70064	47	135100000	85	251322200	109
70164	12	135120000	85	252010000	109
70239	17	135150000	85	252011100	109
70268	16	141100000	15	253030200	106
70269	16	141150000	15	253030300	106
71280	35	141200000	15	253031100	106
76063	70	141300000	15	253031200	106
76089	70	143050000	15	253031600	105
77503	70	143100000	15	253250100	105
3550100	101	143150000	15	253250200	105
3555500	101	143200000	15	254200000	101
3593000	100	145050000	15	254201100	101
3593100	100	145100000	15	254202300	101
100000538	106	145150000	15	254400000	102

No.	Página / Page	No.	Página / Page	No.	Página / Page
254800000	103	524120000	24	710040000	47
254800100	103	530100000	62	710040500	47
263003400	102	530102000	62	716200000	43-52
263003400	103	540010000	15	722100000	43
400010000	27	540012000	15	722200000	43-52
400020000	27	565020100	84	725200000	44
400030000	27	565020200	84	726000000	44
404020000	28	565020300	83	726020000	44
404040000	28	565020400	83	728000000	43
404060000	28	568020000	49	735000000	45
450020000	27	568022400	49	735000500	43-44-45-46
450030000	27	568050000	50	735002300	45
450040000	27	568052400	50	735010500	44
462000000	28	568060000	48	735050000	45
463000000	28	568400000	48	737000500	46
463100000	28	568400300	48	737012200	46
464000000	29	568630000	50	737032200	46
464003000	29	568632400	50	738012200	46
464003100	29	568750000	51	742000000	45
464003400	29	568752400	51	750000000	46
464010100	29	600000000	32	750010000	46
464020000	29	600010000	32	751000000	46
464030000	29	600011500	32	751004100	46
480010000	62	600220500	30	751010000	46
490000000	60	600220600	30	751020000	46
490030000	60	600220800	30	752030000	46
491000000	60	600220900	30	760060000	54
491030000	60	600223500	30	760080000	54
491050000	60	600223600	30	760100000	54
492000000	60	600223700	30	760120000	54
492030000	60	600223800	30	760140000	54
492050000	60	600223900	30	760150000	54
493000000	61	600230000	31	760160000	54
507090000	26	600230100	31	760180000	54
507100000	26	600230200	31	761000000	54
508090000	26	600230400	31	761020000	54
508100000	26	600230500	31	762955300	59
509090000	25	600230600	31	762955700	59
509120000	25	600233100	31	762965100	59
509160000	25	600233200	31	762965200	59
514010000	78	600233300	31	763012200	44-45-46
514010100	78	600233400	31	765100000	55
514010200	78	600240600	30	765120000	55
514010300	78	600240900	30	765140000	55
514010400	78	600243900	30	765160000	55
514010500	78	662200100	31	765180000	55
514010700	78	662200300	31	767050000	55
514011000	78	662200500	31	767750000	55
514011100	78	662300000	31	772201100	56-57
514011200	78	662300100	31	772201200	56-57
514011400	78	670020000	66	785200000	32
514011500	78	670050000	66	851500100	69
520070000	24	701010000	47	851509116	69
522070000	24	701010500	47	855092200	92
522100000	24	701011500	47	855115100	91
522120000	24	701020000	47	855115200	91
524100000	24	710020500	47	855115700	91

No.	Página / Page	No.	Página / Page	No.	Página / Page
855125200	91	990100100	109	150000484	68
855125700	91	995808400	59	150000485	67
855230100	91	1000000419	102	150000530	29
862009000	32	1000000590	64	150000628	75
864020000	35	1000000591	63	150000629	77
864070000	35	1000000592	64	150000670	85
864120200	35	1000000593	65	150000671	77
864220200	35	1000000660	23	150000687	110
864223200	35	1000000661	23	150000688	110
864273200	35	1000000664	23	150000689	110
864280200	35	1000000665	23	150000690	110
864283200	35	1000000668	23	150000691	110
865008700	33	1000000669	23	150000692	110
865200000	33	1000000681	23	150000693	110
865213000	33	1000000682	23	150000694	110
866200000	33	1000000683	23	150000713	110
866203000	33	1000000684	23	1500001065	104
866213000	33	1000000685	23	1500001398	114
881060100	40	1000000687	23	1500001399	114
881060397	40	1000000702	35	1500001400	115
886110000	36	1000000757	56	1500001401	117
886420000	36	1000000946	109	1500001402	116
886427000	40	1000001069	65	1500001403	116
886427100	40	1000001118	35	1500001404	116
886428000	40	1000001450	40	1500001405	116
886428100	40	1000001451	40	1500001406	116
887090100	41	1000001452	40	1500001407	116
887090200	41	1000001453	40	1500001408	61
887090300	41	1000001532	59	1500001408	117
887090500	41	1000001533	59	1500001409	118
887090600	41	1000001534	59	1500001410	118
887090700	41	1000001535	59	1500001485	37
887090800	41	1000001536	59	1500001486	37
887091800	41	1000001537	59	1500001501	114
887092000	41	1000001538	59	1500001589	37
887092100	41	1000001540	59	1500001591	37
887307000	42	1000001543	59	1500001716	110
887308000	42	1000001561	59	1500001987	42
887309000	42	1000001563	59	1500001988	42
890000200	38	1000001626	35	1500002073	42
890010900	38	1000001638	11	1500002157	36
890023700	38	1000001639	11	1500002158	37
890033100	38	1000001640	12	1500002159	37
890033900	38	1000001832	57	1500002233	116
890051000	38	1000001833	57	1500002235	116
891000400	39	1000001834	57	1500002308	57
891060200	40	1000001835	57	1500002662	114
891060597	40	1000001903	63	1500002663	114
894026900	39	1000002163	63	1500002664	115
894070697	40	1200001366	59	1500002665	116
894070897	40	1200001367	59	1500002666	116
897030900	39	1500000233	42	1500002738	46
897035900	39	1500000447	110	1500050105	123
897072800	39	1500000448	110	1500050106	123
899100100	40	1500000449	110	1500050107	123
899200100	40	1500000466	92	071203E	81
899600000	40	1500000468	82	50709C000	26

No.	Página / Page	No.	Página / Page	No.	Página / Page
50710C000	26	F20235000	76	S00750000	31
52710P000	25	F20236000	76	S51404000	80
6000M1600	32	P00109200	105	S51406000	80
6000M2000	32	P002D0300	43	SEH000200	67
6000M2500	32	P00408900	105	SEH000700	89
6000M3200	32	P00508900	105	SEH000800	89
6002D0000	32	P00555500	101	SEH000900	89
6002D4000	32	P00591000	100	SEH001000	86
6002M0000	31	P01100100	12	SEH001100	86
6002N0000	32	P14534300	15	SEH001200	86
6002N4000	32	P85510500	91	SEH001300	87
6003D0000	32	Q86001000	93	SEH001400	87
6003D4000	32	Q86002200	93	SEH003100	75
6003N0000	32	Q86031000	94	SEH003200	90
6003N4000	32	Q86041700	94	SEH003800	102
6004D0000	32	Q86041800	94	SEH003800	104
6004D4000	32	Q86041900	94	SEH004200	79
6004N0000	32	Q86042200	94	SEH004300	79
6004N4000	32	Q86042500	94	SEH004400	79
6005D0000	32	Q86042900	94	SEH004500	79
6005D4000	32	Q86043200	94	SEH004800	68
6005N0000	32	Q86043400	94	SEH005000	68
6005N4000	32	Q86044000	94	SEH0079	66
6006D0000	32	Q86044200	94	SEH009300	75
6006D4000	32	Q86045300	94	SEH009400	75
6006N0000	32	Q86045400	94	SEH009800	79
6006N4000	32	Q87426800	94	SEH009900	79
6007D0000	32	Q87460900	94	SEH010000	75
6007D4000	32	Q87465300	94	SEH010700	75
6007N0000	32	Q87676800	93	SEH010900	75
6007N4000	32	Q87677000	93	SEH011700	75
6008D0000	32	Q87677200	93	SEH011900	75
6008D4000	32	Q87858200	93	SEH012200	75
6008N0000	32	Q87860300	93	SEH019000	70
6008N4000	32	Q87860400	93	SEH019200	85
6009D0000	32	Q87860500	93	SEH020200	40
6009D4000	32	Q87860600	93	SEH020300	101
6009N0000	32	Q87860700	93	SEH020300	102
6009N4000	32	Q87860900	93	SEH020300	104
6621D2200	31	Q87861000	93	SEH020500	100
6621N2200	31	Q87861400	93	SEH020600	40
6622D2200	31	Q87890500	93	SEH0224	66
6622N2200	31	Q87895700	94	SEH022600	69
6623D2200	31	Q87895800	94	SEH022700	69
6623N2200	31	Q87895900	94	SEH022800	69
73500I500	43-44-45	Q87896000	94	SEH0229	82
7350I0500	44-45-46	R22240200	62	SEH0230	82
74200ZB00	45	R3555300	102	SEH0240	82
8515T0116	69	R6020000	63	SEH024600	102
8900N0200	38	R6022000	64	SEH024600	103
8910N0400	39	R6112500	65	SEH024600	104
B40121300	90	S00210000	24	SEH024700	102
B40121500	90	S00220000	24	V12100000	65
B40224300	90	S00230000	26	V15000000	64
B40234300	90	S00260000	80	V39800000	92
F09010600	76	S00520000	49		
F09010800	76	S00630000	31		

Punto de venta SUPER-EGO

POS SUPER-EGO



Ponemos a su disposición expositores para toda nuestra gama de productos. Exponga su producto SUPER-EGO al cliente de una forma atractiva y ordenada, y aumente su ventas.

Le ofrecemos expositores de sobremesa en ciertas herramientas para colocación en mostrador y expositores de pie para generar su zona SUPER-EGO en su tienda.

Consulte las opciones que tenemos.

We have at your disposal Exhibitors for all our range of products. Your Super Ego product will be exhibit it in a neat way to push your sales.

Counter size exhibitors can be offered to generate a Super Ego shop in shop area.

Please do ask for the different options



Vitrina SUPER-EGO

Vitrina cerrada, cómoda para montar. Preparada para colgar la herramienta con ganchos y poder adaptar la distribución al tipo de producto. La medidas totales montada son: 100 x 228 x 45 cm. Dispone de 2 luces LED.



Vitrina (No. 410000573) se suministra con una balda con 2 brazos y 15 ganchos.

Showcase (No. 410000573) it is supplied with 1 shelf with 2 supports and 15 hooks.

Showcase SUPER-EGO

Showcase SUPER-EGO, easy to assemble. It is prepared to hang on the tools on hooks. The overall sizes are 100 x 228 x 45cm. There are 2 LED lights.



Balda + 2 brazos
(No. 410000276).
Shelf + 2 supports
(No. 410000276).

No.		
410000573	Vitrina / Showcase	1
410000276	Balda + 2 brazos / Shelf + 2 supports	1
410000277	10 ganchos / 10 hooks	1

Expositor SUPER-EGO

Expositor abierto, cómodo para montar. Preparado para colgar la herramienta con ganchos y poder adaptar la distribución al tipo de producto. La medidas totales montado con cualquiera de los dos cabeceros son: 100 x 228 x 45 cm.



Expositor (No. 410000270) se suministra con una balda con 2 brazos y 15 ganchos. (No incluye cabecero).

Exhibitor (No. 410000270) it is supplied with 1 shelf and 15 hooks. (Not included head).

Expositor SUPER-EGO

Expositor, easy to assemble. It is prepared to hang on the tools on hooks. The overall sizes with either of the two heads are 100 x 228 x 45 cm.



Cabecero sin luz
(No. 410000272) 100 x 20 cm.
Head without light
(No. 410000272) 100 x 20 cm.



Cabecero con luz
(No. 410000274) 100 x 20 cm.
Head with light
(No. 410000272) 100 x 20 cm.

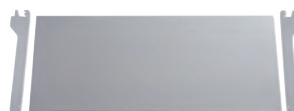

Balda + 2 brazos
(No. 410000276).
Shelf + 2 supports
(No. 410000276).

No.		
410000270	Expositor sin cabecero / Exhibitor with head	1
410000272	Cabecero sin luz / Head without light	1
410000274	Cabecero con luz / Head with light	1
410000276	Balda + 2 brazos / Shelf + 2 supports	1
410000277	10 ganchos / 10 hooks	1

A series of horizontal dashed lines for writing notes.

SUPER EGO, garantía de por vida



Todos nuestros productos están totalmente garantizados de por vida contra defectos de material o fabricación.

La garantía cubre el cambio o reparación de las piezas defectuosas siguiendo el criterio de SUPER-EGO.

Los productos defectuosos deberán ser retornados a SUPER-EGO (ROTHENBERGER Spain) mediante acuerdo escrito.

En el caso de maquinaria eléctrica o electrónica el periodo de garantía será de un año.

SUPER-EGO Garantía de por vida no cubre los defectos o desperfectos ocasionados por el mal uso o abuso de la herramienta.

SUPER-EGO recomienda el uso de repuestos y accesorios propios. Este hábito asegura los estándares de calidad original y extiende la vida útil, así como la garantía de la herramienta.

SUPER EGO, lifetime warranty



All our products are fully guaranteed against defects in workmanship and material.

The guarantee covers the replacement or repair of the defective parts, at SUPER-EGO'S option.

Products found to be defective should be returned to SUPER-EGO (ROTHENBERGER Spain) after written agreement.

In case of electric or electronic machinery the warranty period will be one year.

SUPER-EGO Lifetime Warranty does NOT COVER failures or defects due to abuse or misuse.

SUPER-EGO strongly recommends the use of own replacement parts and accessories. This habit will preserve the original quality standards and extend the life and warranty of the product.



SUPER-EGO TOOLS, S.L.U.

Ctra. Durango-Elorrio, km. 2

48220 - Abadiano SPAIN

Tel.: +34 94 621 01 30 • Fax: +34 94 621 01 31

export@super-ego.es

www.super-ego.es