

Pro-Set[®] cps[®]

Pro-Set[®] TR21 SERIES 2 Cylinder Commercial Refrigerant Recovery Machine

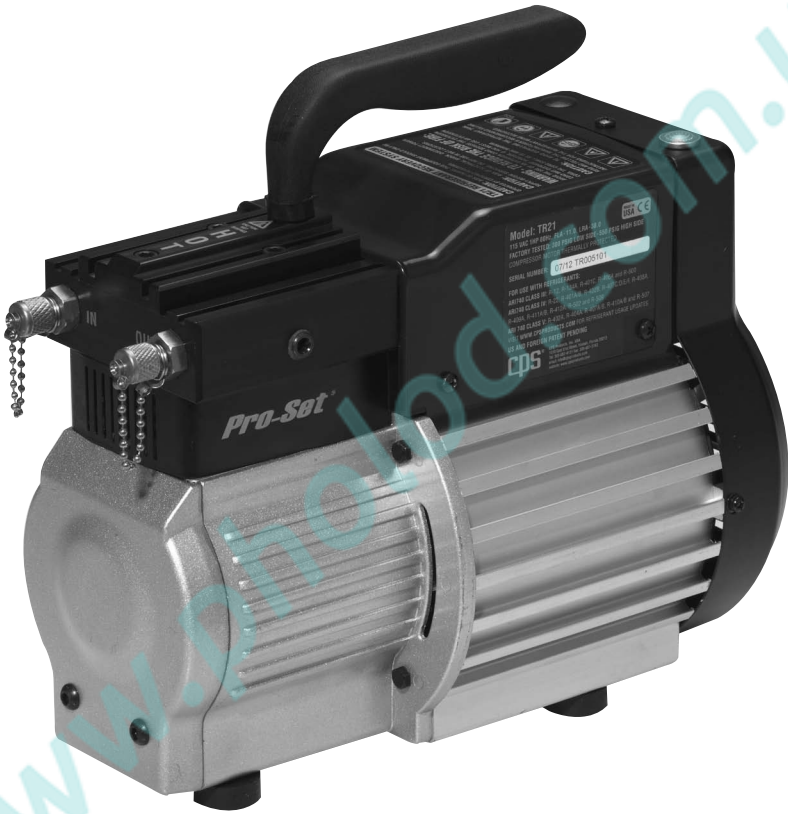

OWNER'S MANUAL (English)

Français, Español, Deutsch and latest updates: www.cpsproducts.com

Series: TR21/C/E/J/S; TR22/C/S

TO BE OPERATED BY QUALIFIED PERSONNEL ONLY



Evaluated for performance in accordance with Sec. 608 of the Clean Air Act (Feb 29, 1996) using AHRI-740-98 test methods.



THIS EQUIPMENT HAS BEEN VERIFIED BY UNDERWRITERS LABORATORIES INC. TO MEET EPA'S MINIMUM REQUIREMENTS FOR RECOVERY EQUIPMENT INTENDED FOR USE WITH ALL SYSTEMS CONTAINING REFRIGERANTS FROM ARI740-98 CATEGORIES III, IV, AND V. UL CONTROL NUMBER 2HA5.

CONTENTS

Key Features	2
General Safety Instructions.....	3
Specifications	4
Unit Layout.....	4
Direct Vapor or Liquid Recovery.....	5
High Speed Direct Liquid Recovery.....	6
Push-Pull Liquid Recovery	7
Routine Maintenance	8
Warranty & Contact Information.....	8

KEY FEATURES

- Maintenance free oil-less compressor design
- Precision machined from aluminum and steel components
- Permanently lubricated and sealed main bearings
- Improved piston seal design for less leakage and deeper vacuums
- 550 psig high pressure cutoff switch with LED indicator
- Cleanable 100 mesh inlet filter
- Weighs less than 25 lbs.
- Fastest recovery rates in its class
- Patent pending cooling system design improves compressor longevity
- Patent pending head design for superior performance

GENERAL SAFETY INSTRUCTIONS

Please read, follow and understand the contents of this entire manual, with special attention given to Danger, Warning and Caution statements.

FOR USE BY PROFESSIONALLY TRAINED AND CERTIFIED OPERATORS ONLY. MOST STATES, COUNTRIES, ETC., MAY REQUIRE USER TO BE LICENSED. PLEASE CHECK WITH YOUR LOCAL GOVERNMENT AGENCY.

- DANGER:** The recovery tank used with this contains liquid refrigerant. Overfilling recovery tank may cause a violent rupture resulting in severe injury or even death. **As a minimum, please use a scale to continuously monitor recovery tank weight. Check local government regulations for recovery tank requirements.**
- DANGER:** **EXPLOSION RISK!** This unit is not certified as 'explosion proof' for explosive rated environments. It is only to be used in normal environments.
- DANGER:** **ELECTRICAL SHOCK HAZARD:** Always disconnect power source when servicing this equipment.
- WARNING:** Do not use equipment in the vicinity of spilled or open containers of gasoline or other flammable substances.
- WARNING:** All hoses may contain liquid refrigerant under pressure. Contact with refrigerant may cause frostbite or other related injuries. Wear proper personal protective equipment such as safety goggles and gloves. When disconnecting any hose, please use extreme caution.
- WARNING: TO REDUCE RISK OF FIRE:** Avoid use of an extension cord because extension cord may overheat. If you must use an extension cord, use 10 awg minimum.
- WARNING:** Avoid breathing refrigerant vapors and lubricant vapor or mist. Breathing high concentration levels may cause heart arrhythmia, loss of consciousness, or even cause suffocation. Exposure may irritate eyes, nose, throat and skin. Please read manufacturer's Material Safety Data Sheet for further safety information on refrigerants and lubricants.
- WARNING:** Make certain all safety devices are functioning properly before operating equipment.
- CAUTION:** To avoid cross contamination of refrigerant and potential leakage to the atmosphere, proper hoses and fittings should be used and checked for damage.
- CAUTION:** To avoid overfilling refrigerant tank, read and follow manufacturer's recommended filling instructions for refrigerant being recovered.
- CAUTION:** This equipment is intended for use of one refrigerant at a time. Mixing of different refrigerants will cause your recovered supply of refrigerant to become contaminated.
Note: It is very expensive to destroy mixed or damaged refrigerants.



SPECIFICATIONS

Model #	TR21	TR22	TR21C	TR22C	TR21J	TR21S	TR22S	TR21E	
Overfill Sensor Cord	✗	✓	✗	✓	✗	✗	✓	✗	
Voltage (Hz)	115 V 60 Hz				100 V 50/60 Hz 1PH	220-240V 50 Hz 1PH			
Motor Size (Horse-power)	2/3								
Motor Thermally Protected	Yes								
Compressor Type	2 Cylinder Oil-less Reciprocating Compressor								
Overload Protection	NA						10 Amp		
Power Consumption	1000 W								
High Pressure Shut-Off	550 psig		450 psig		3.8 MPa	550 psig		525 psig (38 bar)	
Auto or Manual Reset	Auto		Auto		Auto	Auto		Manual	
Refrigerants	ARI740 Class III		R-12, R-134a, R-401C, R-406A, R-500, R-1234yf/ze					R-12, R-134a, R-401C, R-500	
	ARI740 Class IV		R-22, R-401A/B, R-402B, R-407C/D/E/F, R408A, R-409A, R-411A/B, R-412A, R-502, R-509A					R-22, R-401A/B, R-402B, R-407C/D/E/F, R408A, R-502, R-509A	
	ARI740 Class V		R-32, R-402A, R-404A, R-407A/B, R-410A/B, R-507A					R-402A, R-404A, R-410A/B, R-507A	
Operating Temperature Range	32°F to 120°F (0°C to 49°C)								
Power Cord Length	6 ft. (1.82 m)								
Dimensions	6" x 12" x 9" (15cm x 30cm x 23cm)								
Weight	24.3 lbs (11.0 kg)								
Approvals	UL (AHRI 74-98) CE, CSA, TUV								
Warranty (Years)	1								

Verified UL Flow Rate @ 60Hz (Reduce 15% for all 50Hz models)

Refrigerant	Direct Vapor	Direct Liquid	Push - Pull Liquid	High Temp Vapor Rate
R-410a	0.703 lb (.319 kg)	11.95 lb (5.42 kg)	31.70 lb (14.38 kg)	0.816 lb (0.370 kg)
R-22	0.597 lb (.271 kg)	8.86 lb (4.02 kg)	31.53 lb (14.30 kg)	0.860 lb (0.390 kg)
R-134a	0.503 lb (.228 kg)	7.80 lb (3.54 kg)	25.66 lb (11.64 kg)	----
R407c	0.536 (.243 kg)	9.50 lb (4.31 kg)	29.14 lb (13.22 kg)	----

*Evaluated for performance in accordance with Sec. 608 of the Clean Air Act (Feb 29, 1996) using AHRI-740-98 test methods.

TR21 SERIES UNIT LAYOUT

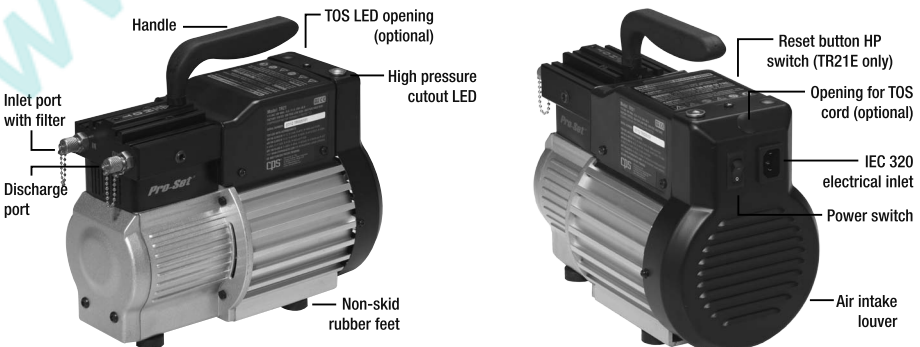

DIRECT VAPOR OR LIQUID RECOVERY

The following is recommended to maximize recovery rates;

- A. Use shortest length 3/8" (Inside Diameter) Refrigeration Hose on Suction Side of Recovery Unit.
- B. If Recovery Unit trips OFF on HIGH Pressure, change recovery cylinder.
- C. When recovering large amounts of R410A, or if recovering under very high ambient temperatures, we suggest using the CPS MT69 (Molecular Transformator) which will increase the recovery speed.

1. Connect TR21 as shown in **Diagram 1**. Use a refrigerant manifold and one spare hose. Manifold should be connected between the unit being serviced and TR21 **IN** port. Spare hose should connect from TR21 **OUT** port to an evacuated recovery tank vapor valve.

Note: Check local government regulations for recovery tank requirements.

2. Open vapor valve on recovery tank.
3. Keep manifold valves closed at this time.
4. Push main power switch "ON".
5. Once unit has started, open both HI & LO manifold valves to start refrigerant recovery flow.

Note: TR21 is designed to directly recover large amounts of liquid refrigerant. If during vapor recovery process the compressor begins to make a slugging or hammering noise, meter incoming liquid refrigerant by closing low side manifold valve until noise subsides.

6. TR21 will run continuously. When a 10" hg. vacuum is observed on low side manifold gauge, close both **LO** & **HI** side manifold valves off.
7. If pressure on the manifold gauges start to rise, repeat steps 4-7. If manifold gauges remain in a vacuum, close all tank, manifold and hose valves. Remove discharge hose from TR21 outlet port.

Recovery and Self-Clearing are now complete.

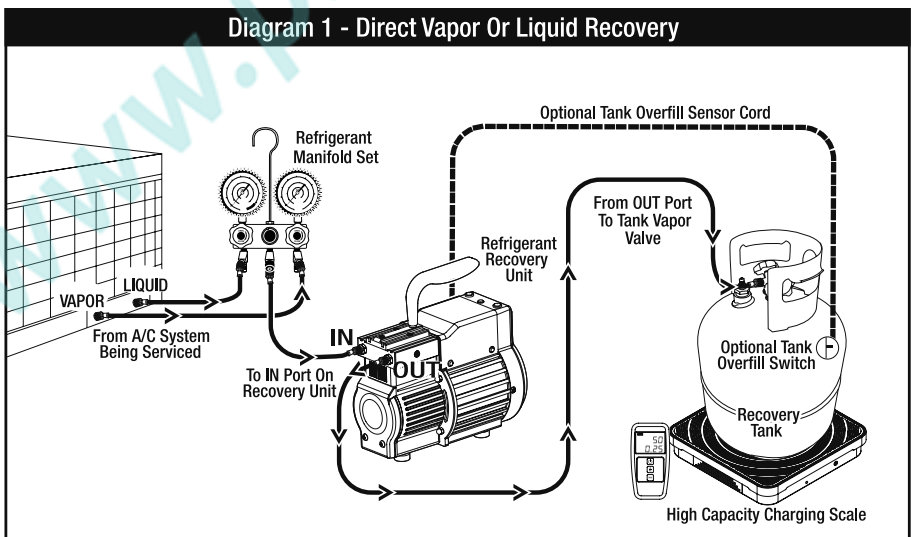

HIGH SPEED DIRECT LIQUID RECOVERY

The following is recommended to maximize recovery rates;

- A. Use shortest length 1/4" (Inside Diameter) Refrigeration hose on suction side and discharge side of unit.
 - B. If Recovery Unit trips OFF on HIGH Pressure, change recovery cylinder.
 - C. Use an evacuated tank.
 - D. Install a hose between recovery tank and vapor service valve on the A/C system being serviced. (See Diagram 2)
 - E. Use 90lb recovery tank or larger to minimize tank change over.
1. Connect TR21 as shown in **Diagram 2**. Use a refrigerant manifold (with sight glass) and two spare hoses. The manifold should be connected between unit being serviced and TR21 **IN** port. Connect a refrigerant hose from TR21 **OUT** port to an evacuated recovery tank liquid valve. Connect another refrigerant hose from tank vapor port to a service port of the unit being serviced. **Note: Recovery tank must be rated for (38 bar) 550 PSI.**
 2. Open both vapor and liquid valves on recovery tank.
 3. Keep manifold valves closed at this time.
 4. Push main power switch "ON".
 5. Once unit has started, open **LO** manifold valve on manifold to start liquid refrigerant flow to the TR21. Monitor liquid refrigerant flow in manifold sight glass.

Note: TR21 is designed to directly recover large amounts of liquid refrigerant. If during vapor recovery process the compressor begins to make a slugging or hammering noise, meter incoming liquid refrigerant by closing low side manifold valve until noise subsides.

6. Once liquid refrigerant is no longer present in manifold sight glass, close recovery tank vapor valve. Open the **HI** side manifold valve. This will transition unit into direct vapor recovery.
7. Allow TR21 to run continuously. When a 10" hg. vacuum is observed on low side manifold gauge, close both **LO & HI** side manifold valves off.
8. If pressure on manifold gauge starts to rise, open both manifold valve and restart TR21. If the manifold gauge remains in a vacuum, close all tank, manifold and hose valves. Remove discharge hose from TR21 outlet port.

Recovery and Self-Clearing are now complete.

Diagram 2 - High Speed Direct Liquid Recovery

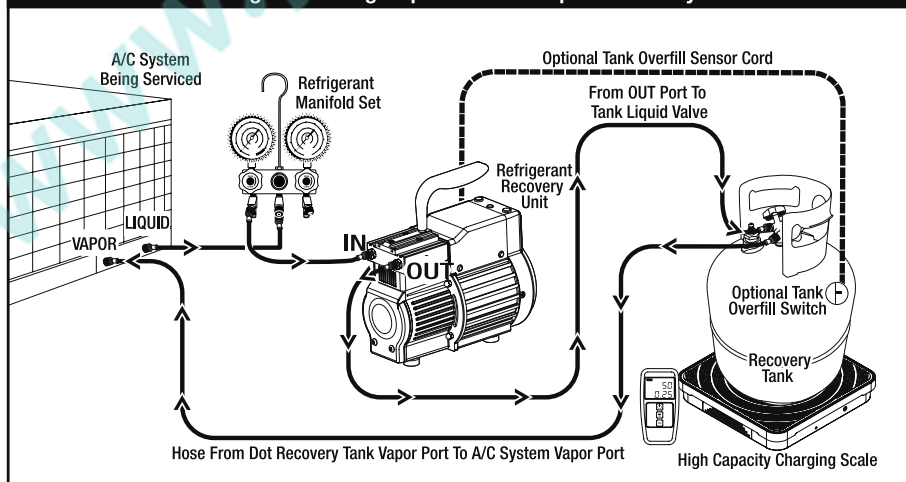

PUSH-PULL LIQUID RECOVERY

The following is recommended to maximize recovery rates;

- A. Use shortest length 3/8" (Inside Diameter) Refrigeration Hose on Suction Side of Recovery Unit to Vapor Port on Tank.
 - B. Use 3/8" (Inside Diameter) Refrigerant Hoses from system Liquid Service Valve to LIQUID Port on Recovery Tank.
 - C. Use an evacuated tank (90lb or larger, and rated for 550 PSI/38 Bar).
1. Connect TR21 as shown in **Diagram 3**. Use a refrigerant manifold with sight glass and two spare hoses. Manifold should be connected between liquid service port of system being serviced and recovery tank liquid valve. One spare hose should connect from TR21 **IN** port to recovery tank vapor valve. The other spare hose should connect from TR21 **OUT** port to vapor service port on system being serviced.
 2. Close manifold **LO** side valve. Open manifold **HI** side valve. Open recovery tank's liquid valve.
 3. Push main power switch "**ON**".
 4. Open recovery tank vapor valve. A Push-Pull flow is now enabled.
 5. Monitor scale for recovery tank capacity.
 6. Monitor sight glass in manifold for presence of liquid refrigerant. Once liquid refrigerant is no longer being pushed out of A/C system being recovered, close vapor valve on recovery tank. Let run for 30 seconds, then turn off unit.

Note: Push-Pull recovery does not completely recover all refrigerant. Proceed to Direct Vapor Recovery Operation (page 5) to complete the recovery process.

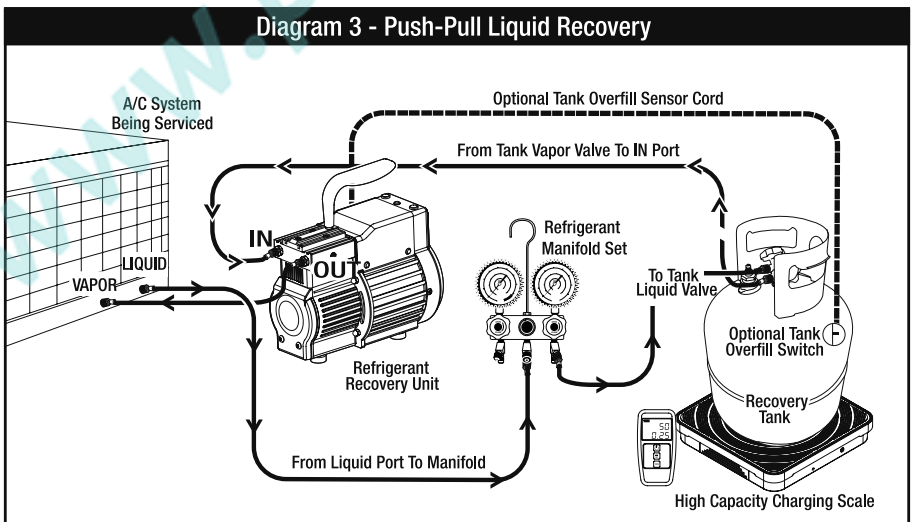

ROUTINE MAINTENANCE

Filter Maintenance: TR21 is equipped with a 100-mesh screen filter. Check filter periodically. A partially clogged filter will slow recovery rate.

Check filter as follows:

1. Use a 5/8" socket or box end wrench to remove IN port (Figure 1).
2. Remove suction port-filter in (Figure 2).
3. Clean filter or replace with new filter (CPS #CRXF3).
4. Inspect O-ring. Re-lubricate with compressor oil or equivalent.
5. Place filter back into suction port fitting.
6. Hand tighten assembly back onto TR21.
7. Use 5/8" socket or box end wrench to tighten 1/8 of a turn. Do not over tighten; O-ring damage may occur.
8. Check connection for leaks.

Piston Seal Maintenance: In cases of virgin refrigerant recovery, it is recommended to add .25 ounce of refrigerant oil to inlet port before each use.

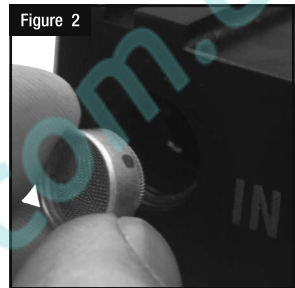
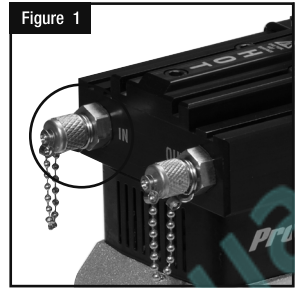

WARRANTY

CPS® Products, Inc. guarantees that all products are free of manufacturing and material defects to the original owner for one year from date of purchase. If equipment should fail during guarantee period it will be repaired or replaced (at our option) at no charge. This guarantee does not apply to equipment that has been altered, misused or solely in need of field service maintenance. All repaired equipment will carry an independent 90 day warranty. This repair policy does not include equipment that is determined to be beyond economical repair. **WARRANTY DISCLAIMER:** Use this device to recover only HVAC/R refrigerants from sealed HVAC/R systems. **WARRANTY VOIDED IF USED FOR ANY OTHER PURPOSE.**

LOCATIONS

CPS PRODUCTS, INC.
U.S.A. (Headquarters)
1010 East 31st Street,
Hialeah, Florida 33013, USA
Tel: 305-687-4121,
1-800-277-3808
Fax: 305-687-3743
E-mail:
info@cpsproducts.com
Website:
www.cpsproducts.com

CPS PRODUCTS
CANADA LTD.
1324 Blundell Road
Mississauga, ON, L4Y 1M5
Tel: 905.615.8620
Fax: 905.615.9745
E-mail:
info@cpsproducts.com
Website:
www.cpsproducts.com

CPS PRODUCTS N.V
Krijgsbaan 241, 2070
Zwijndrecht, Belgium
Tel: (323) 281 30 40,
E-mail:
info@cpsproducts.be
Website:
www.cpsproducts.com

CPS AUSTRALIA PTY. LTD.
109 Welland Avenue,
Welland, South Australia 5007
Tel: +61 8 8340 7055,
E-mail:
sales@cpsaustralia.com.au
Website:
www.cpsproducts.com

For latest update to this owner's manual, go to www.cpsproducts.com